

***User's Guide***  
**AC Power Solutions**  
**Agilent Models 6811B, 6812B, and 6813B**

Agilent Part No. 5962-0829  
Microfiche No 5962-0830



Printed in Malaysia  
September 2004

---

# Warranty Information

## CERTIFICATION

*Agilent Technologies certifies that this product met its published specifications at time of shipment from the factory. Agilent Technologies further certifies that its calibration measurements are traceable to the United States National Bureau of Standards, to the extent allowed by the Bureau's calibration facility, and to the calibration facilities of other International Standards Organization members.*

## WARRANTY

This Agilent Technologies hardware product is warranted against defects in material and workmanship for a period of one year from date of delivery. Agilent Technologies software and firmware products, which are designated by Agilent Technologies for use with a hardware product and when properly installed on that hardware product, are warranted not to fail to execute their programming instructions due to defects in material and workmanship for a period of 90 days from date of delivery. During the warranty period Agilent Technologies will, at its option, either repair or replace products which prove to be defective. Agilent Technologies does not warrant that the operation for the software firmware, or hardware shall be uninterrupted or error free.

For warranty service, with the exception of warranty options, this product must be returned to a service facility designated by Agilent Technologies. Customer shall prepay shipping charges by (and shall pay all duty and taxes) for products returned to Agilent Technologies for warranty service. Except for products returned to Customer from another country, Agilent Technologies shall pay for return of products to Customer.

Warranty services outside the country of initial purchase are included in Agilent Technologies product price, only if Customer pays Agilent Technologies international prices (defined as destination local currency price, or U.S. or Geneva Export price).

If Agilent Technologies is unable, within a reasonable time to repair or replace any product to condition as warranted, the Customer shall be entitled to a refund of the purchase price upon return of the product to Agilent Technologies.

## LIMITATION OF WARRANTY

The foregoing warranty shall not apply to defects resulting from improper or inadequate maintenance by the Customer, Customer-supplied software or interfacing, unauthorized modification or misuse, operation outside of the environmental specifications for the product, or improper site preparation and maintenance. NO OTHER WARRANTY IS EXPRESSED OR IMPLIED. AGILENT TECHNOLOGIES SPECIFICALLY DISCLAIMS THE IMPLIED WARRANTIES OF MERCHANTABILITY AND FITNESS FOR A PARTICULAR PURPOSE.

## EXCLUSIVE REMEDIES

THE REMEDIES PROVIDED HEREIN ARE THE CUSTOMER'S SOLE AND EXCLUSIVE REMEDIES. AGILENT TECHNOLOGIES SHALL NOT BE LIABLE FOR ANY DIRECT, INDIRECT, SPECIAL, INCIDENTAL, OR CONSEQUENTIAL DAMAGES, WHETHER BASED ON CONTRACT, TORT, OR ANY OTHER LEGAL THEORY.

## ASSISTANCE

The above statements apply only to the standard product warranty. Warranty options, extended support contacts, product maintenance agreements and customer assistance agreements are also available. Contact your nearest Agilent Technologies Sales and Service office for further information on Agilent Technologies' full line of Support Programs.

---

# Safety Summary

*The following general safety precautions must be observed during all phases of operation of this instrument. Failure to comply with these precautions or with specific warnings elsewhere in this manual violates safety standards of design, manufacture, and intended use of the instrument. Agilent Technologies assumes no liability for the customer's failure to comply with these requirements.*

## **WARNING: LETHAL VOLTAGES**

Ac sources can supply 425 V peak at their output. DEATH on contact may result if the output terminals or circuits connected to the output are touched when power is applied.

## **GENERAL**

This product is a Safety Class 1 instrument (provided with a protective earth terminal). The protective features of this product may be impaired if it is used in a manner not specified in the operation instructions.

Any LEDs used in this product are Class 1 LEDs as per IEC 825-1.

This ISM device complies with Canadian ICES-001. Cet appareil ISM est conforme à la norme NMB-001 du Canada.

## **ENVIRONMENTAL CONDITONS**

This instrument is intended for indoor use in an installation category II, pollution degree 2 environment. It is designed to operate at a maximum relative humidity of 95% and at altitudes of up to 2000 meters. Refer to the specifications tables for the ac mains voltage requirements and ambient operating temperature range.

## **BEFORE APPLYING POWER**

Verify that the product is set to match the available line voltage, the correct fuse is installed, and all safety precautions are taken. Note the instrument's external markings described under "Safety Symbols".

## **GROUND THE INSTRUMENT**

To minimize shock hazard, the instrument chassis and cover must be connected to an electrical ground. The instrument must be connected to the ac power mains through a grounded power cable, with the ground wire firmly connected to an electrical ground (safety ground) at the power outlet. Any interruption of the protective (grounding) conductor or disconnection of the protective earth terminal will cause a potential shock hazard that could result in personal injury.

**ATTENTION: Un circuit de terre continu est essentiel en vue du fonctionnement sécuritaire de l'appareil. Ne jamais mettre l'appareil en marche lorsque le conducteur de mise ... la terre est d,branch,.**

## **FUSES**

Only fuses with the required rated current, voltage, and specified type (normal blow, time delay, etc.) should be used. Do not use repaired fuses or short-circuited fuseholders. To do so could cause a shock or fire hazard.

## **DO NOT OPERATE IN AN EXPLOSIVE ATMOSPHERE**

Do not operate the instrument in the presence of flammable gases or fumes.

## **DO NOT REMOVE THE INSTRUMENT COVER**

Operating personnel must not remove instrument covers. Component replacement and internal adjustments must be made only by qualified service personnel.

*Instruments that appear damaged or defective should be made inoperative and secured against unintended operation until they can be repaired by qualified service personnel.*

## SAFETY SYMBOLS



Direct current



Alternating current



Both direct and alternating current



Three-phase alternating current



Earth (ground) terminal



Protective earth (ground) terminal



Frame or chassis terminal



Terminal is at earth potential. Used for measurement and control circuits designed to be operated with one terminal at earth potential.



Terminal for Neutral conductor on permanently installed equipment



Terminal for Line conductor on permanently installed equipment



On (supply)



Off (supply)



Standby (supply). Units with this symbol are not completely disconnected from ac mains when this switch is off. To completely disconnect the unit from ac mains, either disconnect the power cord or have a qualified electrician install an external switch.



In position of a bi-stable push control



Out position of a bi-stable push control



Caution, risk of electric shock



Caution, hot surface



Caution (refer to accompanying documents)



### WARNING

The WARNING sign denotes a hazard. It calls attention to a procedure, practice, or the like, which, if not correctly performed or adhered to, could result in personal injury. Do not proceed beyond a WARNING sign until the indicated conditions are fully understood and met.

### Caution

The CAUTION sign denotes a hazard. It calls attention to an operating procedure, or the like, which, if not correctly performed or adhered to, could result in damage to or destruction of part or all of the product. Do not proceed beyond a CAUTION sign until the indicated conditions are fully understood and met.

# Declaration Page

 <b>Agilent Technologies</b>	<b>DECLARATION OF CONFORMITY</b> According to ISO/IEC Guide 22 and CEN/CENELEC EN 45014	
---	--	---

**Manufacturer's Name and Address**

Responsible Party

Agilent Technologies, Inc.  
550 Clark Drive, Suite 101  
Budd Lake, New Jersey 07828  
USA

Alternate Manufacturing Site

Agilent Technologies (Malaysia) Sdn. Bhd  
Malaysia Manufacturing  
Bayan Lepas Free Industrial Zone, PH III  
11900 Penang,  
Malaysia

Declares under sole responsibility that the product as originally delivered

- |                        |  |
|------------------------|--|
| <b>Product Names</b>   | Single phase ac Power Source/Analyzer  |
| <b>Model Numbers</b>   | 6811B, 6812B, 6813B<br>(and other customized products based upon the above)              |
| <b>Product Options</b> | This declaration covers all options and customized products based on the above products. |

Complies with the essential requirements of the Low Voltage Directive 73/23/EEC and the EMC Directive 89/336/EEC (including 93/68/EEC) and carries the CE Marking accordingly.

**EMC Information** ISM Group 1 Class A Emissions

As detailed in Electromagnetic Compatibility (EMC), Certificate of Conformance Number CC/TCF/00/079 based on Technical Construction File (TCF) HPNJ6, dated June 10, 1999.

Assessed by: Celestica Ltd, Appointed Competent Body  
Westfields House, West Avenue  
Kidsgrove, Stoke-on-Trent  
Staffordshire, ST7 1TL  
United Kingdom

**Safety Information** and Conforms to the following safety standards.

- IEC 61010-1:2001 / EN 61010-1:2001
- Canada: CSA C22.2 No. 1010.1:1992
- UL 61010B-1: 2003

This DoC applies to the above-listed products placed on the EU market after:

January 1, 2004

Date



Bill Darcy/ Regulations Manager

For further information, please contact your local Agilent Technologies sales office, agent or distributor.  
*Authorized EU-representative: Agilent Technologies Deutschland GmbH, Herrenberger Straße 130, D71034 Böblingen, Germany*

---

## Acoustic Noise Information

### Herstellerbescheinigung

Diese Information steht im Zusammenhang mit den Anforderungen der Maschinenläminformationsverordnung vom 18 Januar 1991.

- \* Schalldruckpegel  $L_p < 70$  dB(A)
- \* Am Arbeitsplatz
- \* Normaler Betrieb
- \* Nach EN 27779 (Typprüfung).

### Manufacturer's Declaration

This statement is provided to comply with the requirements of the German Sound Emission Directive, from 18 January 1991.

- \* Sound Pressure  $L_p < 70$  dB(A)
- \* At Operator Position
- \* Normal Operation
- \* According to EN 27779 (Type Test).

---

## Printing History

The edition and current revision of this manual are indicated below. Reprints of this manual containing minor corrections and updates may have the same printing date. Revised editions are identified by a new printing date. A revised edition incorporates all new or corrected material since the previous printing date.

Changes to the manual occurring between revisions are covered by change sheets shipped with the manual. In some cases, the manual change applies only to specific instruments. Instructions provided on the change sheet will indicate if a particular change applies only to certain instruments.

This document contains proprietary information protected by copyright. All rights are reserved. No part of this document may be photocopied, reproduced, or translated into another language without the prior consent of Agilent Technologies. The information contained in this document is subject to change without notice.

© Copyright 1995, 1997, 1998 Agilent Technologies, Inc.

Edition 1 \_\_\_\_\_ August, 1995  
Edition 2 \_\_\_\_\_ February, 1997  
Edition 3 \_\_\_\_\_ March, 1998  
Edition 4 \_\_\_\_\_ December 1998  
Update 1 \_\_\_\_\_ April 2000  
Update 2 \_\_\_\_\_ September 2004

---

# Table of Contents

Warranty Information	2
Safety Summary	3
Declaration of Conformity	5
Acoustic Noise Information	6
Printing History	6
Table of Contents	7
<b>1 GENERAL INFORMATION</b>	<b>11</b>
<b>Document Orientation</b>	<b>11</b>
Earlier AC Source Models	12
Safety Considerations	12
<b>Options and Parts</b>	<b>12</b>
<b>Description</b>	<b>13</b>
Capabilities	14
<b>Front Panel/Remote Operation</b>	<b>14</b>
<b>Steady-state Output Characteristic</b>	<b>15</b>
<b>Peak Current/Dynamic Power Capability</b>	<b>16</b>
Peak Current Limit	16
Peak Inrush Example	16
<b>RMS Current Limit Circuit</b>	<b>17</b>
<b>Voltage Regulation</b>	<b>18</b>
Real Time Regulation	18
RMS Regulation	18
<b>Output Impedance</b>	<b>18</b>
<b>Output Coupling</b>	<b>19</b>
<b>2 INSTALLATION</b>	<b>21</b>
<b>Inspection</b>	<b>21</b>
Damage	21
Packaging Material	21
Items Supplied	21
Cleaning	21
<b>Location</b>	<b>22</b>
Bench Operation	22
Rack Mounting	22
<b>Input Connections</b>	<b>23</b>
Input Source and Line Fuse	23
Installing the Power Cord	23
<b>Output Connections</b>	<b>24</b>
Wire Considerations	25
Voltage Drops	25
<b>Remote Sense Connections</b>	<b>25</b>
Remote Sensing and OVP Considerations	27
<b>Trigger Connections</b>	<b>27</b>
<b>Digital Connections</b>	<b>27</b>
<b>Controller Connections</b>	<b>28</b>
GPIB Connector	28
RS-232 Interface	29

<b>3 TURN-ON CHECKOUT</b>	<b>31</b>
<b>Introduction</b>	<b>31</b>
<b>Preliminary Checkout</b>	<b>31</b>
<b>Using the Keypad</b>	<b>32</b>
<b>Checkout Procedure</b>	<b>32</b>
<b>In Case of Trouble</b>	<b>34</b>
Error Messages	34
Line Fuse	35
<b>4 FRONT PANEL OPERATION</b>	<b>37</b>
<b>Introduction</b>	<b>37</b>
<b>Front Panel Description</b>	<b>37</b>
<b>System Keys</b>	<b>39</b>
<b>Function Keys</b>	<b>40</b>
Immediate Action Keys	40
Scrolling Keys	40
Meter Display Keys	41
Output Control Keys	42
Protection and Status Control Keys	44
Trigger and List Control Keys	45
<b>Entry Keys</b>	<b>46</b>
<b>Examples of Front Panel Programming</b>	<b>47</b>
1 - Setting the Output Voltage Amplitude	47
2 - Setting the Output Frequency	48
3 - Setting the DC Offset	48
4 - Setting a Protection Feature	48
5 - Clearing Protection Conditions	49
6 - Using Transient Voltage Modes	50
7 - Trigger Delays and Phase Synchronization	53
8 - Using Slew Rates to Generate Waveforms	55
9 - Measuring Peak Inrush Current	57
10 - Setting the GPIB Address and RS-232 Parameters	58
11 - Saving and Recalling Operating States	58
<b>A SPECIFICATIONS</b>	<b>59</b>
<b>Specifications</b>	<b>59</b>
<b>Supplemental Characteristics</b>	<b>61</b>
<b>Operation Below 45 Hz</b>	<b>63</b>
<b>B VERIFICATION AND CALIBRATION</b>	<b>65</b>
<b>Introduction</b>	<b>65</b>
Equipment Required	65
Test Setup	66
<b>Performing the Verification Tests</b>	<b>67</b>
Turn-On Checkout Procedure	67
AC Voltage Programming and Measurement Accuracy	67
DC Voltage Programming and Measurement Accuracy	68
RMS Current Accuracy Test	68
<b>Performing the Calibration Procedure</b>	<b>71</b>
Front Panel Calibration Menu	71
<b>Front Panel Calibration</b>	<b>72</b>
Enable Calibration Mode	72



Calibrating and Entering Voltage Offset Values	72
Calibrating and Entering DC Voltage Gain Values	73
Calibrating and Entering AC rms Voltage Gain Values	73
Calibrating the OVP Trip Point	74
Calibrating and Entering rms Current Values	74
Calibrating and Entering rms Current Measurement Values	75
Calibrating the Output Impedance	75
Saving the Calibration Constants	75
<b>Changing the Calibration Password</b>	<b>76</b>
<b>Calibration Error Messages</b>	<b>76</b>
<b>Calibration Over the GPIB</b>	<b>76</b>
Agilent Calibration Program Listing	76
<b>C ERROR MESSAGES</b>	<b>81</b>
Error Number List	81
<b>D LINE VOLTAGE CONVERSION</b>	<b>85</b>
Open the Unit	85
Check the Jumper Wire (Model Agilent 6811B/6812B only)	85
Check the Line Jumpers (all Models)	85
Check the Power Transformer Connector (all Models)	85
Close the Unit	86
<b>INDEX</b>	<b>87</b>



## General Information

---

### Document Orientation

This manual describes the operation of the Agilent 6811B/6812B/6813B AC Power Solutions. These units will be referred to as "ac sources" throughout this manual. The following documents are shipped with your ac source:

- ◆ a Quick-Start Guide, to help you quickly get started using the ac source
- ◆ a User's Guide, containing detailed installation, checkout, and front panel information
- ◆ a Programming Guide, containing detailed GPIB programming information
- ◆ a Quick Reference Card, designed as a memory jogger for the experienced user

You will find information on the following tasks in these guides. Refer to the table of contents of each guide for a complete list of the topics.

Topic	Location
Accessories and Options	Chapter 1 - this guide
Calibrating the ac source	Appendix B - this guide
Front panel keys	Chapter 4 - this guide
Front panel programming examples	Chapter 4 - this guide
Line voltage connections	Chapter 2 - this guide
Line voltage ratings	Appendix A - this guide
Line voltage conversion	Appendix D - this guide
Operator replaceable parts	Chapter 1 - this guide
Operator troubleshooting	Chapter 3 - this guide
Operating characteristics	Appendix A - this guide
Performance specifications	Appendix A - this guide
Quick operating checkout	Chapter 3 - this guide
Rack mounting	Chapter 2 - this guide
RS-232 operation	Chapter 2 - this guide
SCPI programming examples	Chapter 3 - Programming Guide
SCPI programming commands	Chapter 4 - Programming Guide
Turn-on/checkout	Chapter 3 - this guide
Wiring - discrete fault indicator (DFI)	Chapter 2 - this guide
- GPIB controller	Chapter 2 - this guide
- load or loads	Chapter 2 - this guide
- voltage sensing (local and remote)	Chapter 2 - this guide
- remote inhibit (RI)	Chapter 2 - this guide

## 1 - General Information

### Earlier AC Source Models

With the exception of some minor readback specification differences, information in this manual also applies to the following earlier ac source models:

Information about this model	also applies to the following earlier models:
Agilent 6811B	Agilent 6811A AC Power Source/Analyzer
Agilent 6812B	Agilent 6812A AC Power Source/Analyzer Agilent 6841A Harmonic/Flicker Test System in normal mode
Agilent 6813B	Agilent 6813A AC Power Source/Analyzer Agilent 6842A Harmonic/Flicker Test System in normal mode

### Safety Considerations

This ac source is a Safety Class 1 instrument, which means it has a protective earth terminal. That terminal must be connected to earth ground through a power source equipped with a ground receptacle. Refer to the Safety Summary page at the beginning of this guide for general safety information. Before installation or operation, check the ac source and review this guide for safety warnings and instructions. Safety warnings for specific procedures are located at appropriate places in the guide.

## Options and Parts

**Table 1-1. Options**

Option	Model	Description
1CM*	All	Rack mount kit (Agilent p/n 5062-3977)
1CP*	All	Rack mount kit with handles (Agilent p/n 5062-3983)
100	Agilent 6811B/6812B	87-106 Vac, 48-63 Hz (Japan only)
120	Agilent 6811B/6812B	104-127 Vac, 48-63 Hz
200	Agilent 6813B	174-106 Vac, 48-63 Hz (Japan only)
230	Agilent 6811B/6812B	191-254 Vac, 48-63 Hz
831	Agilent 6812B/6813B	12 AWG, 200 to 240 Vac, unterminated
832	Agilent 6813B	4-mm <sup>2</sup> wire size, unterminated
833	Agilent 6812B	1.5-mm <sup>2</sup> wire size, 200 to 240 Vac, unterminated
834	Agilent 6812B	10 AWG, 100 to 120 Vac, unterminated
841	Agilent 6812B/6813B	Line cord with NEMA 6-20P; 20A, 250 V plug
842	Agilent 6813B	Line cord with IEC 309; 32A, 220 V plug
844	Agilent 6813B	Line cord with NEMA 6-30P; 30A, 250 V locking plug
845	Agilent 6812B	Line cord with IEC 309; 16 A, 220 V plug
846	Agilent 6812B	Line cord with NEMA L5-30P; 30 A, 120 V plug
847	Agilent 6812B	Line cord with CEE 7/7; 16 A, 220 V plug
848	Agilent 6812B	Line cord with BS 546; 15 A, 240 V plug
900	Agilent 6811B	Line cord with BS 1363/A (90 deg); 10 A, 240 V plug
901	Agilent 6811B	Line cord with AS 3112 (straight); 10 A, 240 V plug
902	Agilent 6811B	Line cord with CEE 7/7 (straight); 10 A, 230 V plug
903	Agilent 6811B	Line cord with NEMA 5-15P (straight); 13 A, 120 V plug
904	Agilent 6811B	Line cord with NEMA 6-15P (straight); 10 A, 230 V plug
906	Agilent 6811B	Line cord with SEV Type 12; 10 A, 220/230 V plug
912	Agilent 6811B	Line cord with SR107-2-D (straight); 10 A, 220/230 V plug
917	Agilent 6811B	Line cord with SABS 164-1 (90 deg); 10 A, 220-250 V plug

918	Agilent 6811B	Line cord with JIS 8303 (straight); 12 A, 100/110 V plug
919	Agilent 6811B	Line cord with SI 32 (90 deg); 10 A, 220 V plug
920	Agilent 6811B	Line cord with IRAM 2073 (90 deg); 10 A, 220 V plug
921	Agilent 6811B	Line cord with CEI 23-16; 10 A, 220 V plug
922	Agilent 6811B	Line cord with GB 1002 (straight); 10 A, 220 V plug
927	Agilent 6811B	Line cord with NEMA 5-15P; 10 A, 220 V plug

\*Support rails (Agilent p/n 1494-0059) are required when rack mounting units with options 1CM and 1CP.

**Table 1-2. Operator Replaceable Parts**

Item	Agilent Part Number
Power cord assembly	see "Options"
Rack mount kit	see "Options"
4-terminal digital connector plug	1252-1488
Ac input safety cover (with strain relief and bushing)	5040-1676
Screw (3), ac input barrier block (6-32 x 5/16in)	N/A
Ac output safety cover	5040-1704
Line fuse for Agilent 6812B (30 AM)	2110-0910
Line fuse for Agilent 6813B (25 AM)	2110-0849
Line fuse for Agilent 6811B (20 AM)	2110-0098
Screw (2), ac output safety cover (m4 x 0.7in)	0515-0053
Screw (5), ac output barrier block (6-32 x 5/16 in)	N/A
User's Guide (this manual)	5962-0829
Programming Guide	5962-0889
Quick Start Guide	5962-0883
Quick Reference Card	5962-0885

## Description

The ac source combines three instruments in one unit as shown in the following figure. The function generator produces waveforms with programmable amplitude, frequency, and shape. The power amplifier amplifies the function generator signal to produce the ac power for your application. The measurement functions range from a simple readback of rms voltage and current, to sophisticated capabilities such as waveform analysis.

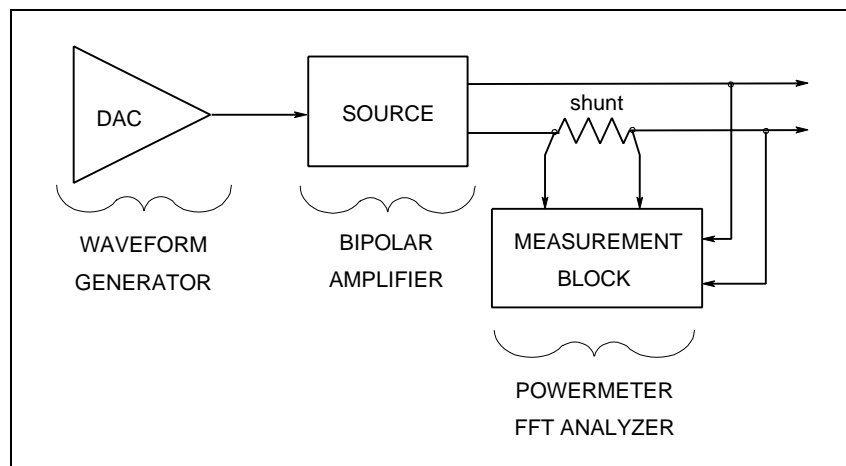

**Figure 1-1. AC Source Functional Elements**

## 1 - General Information

The following model ac power sources are described in this User's Guide:

<b>Model</b>	<b>Description</b>
Agilent 6811B	0-300 V rms; 375 VA (425 V peak; 40 A peak)
Agilent 6812B	0-300 V rms; 750 VA (425 V peak; 40 A peak)
Agilent 6813B	0-300 V rms; 1750 VA (425 V peak; 80 A peak)

### Capabilities

- ◆ Programmable ac voltage, dc voltage, frequency, phase, and current limit.
- ◆ Sine, square, clipped sine, and user-definable waveforms.
- ◆ Programmable output impedance.
- ◆ Voltage and frequency slew control.
- ◆ Synthesized waveform generation for high resolution and accuracy in frequency, low waveform distortion, and glitch-free phase transitions.
- ◆ Step and pulse output transients for generating surge, sag, dropout, and other line disturbance simulations.
- ◆ Nonvolatile list programming for generating complex output transients or test sequences.
- ◆ Nonvolatile state and waveform storage and recall.
- ◆ Extensive measurement capability:
  - Ac rms, dc, ac+dc voltage and current and peak current.
  - Real, reactive, and apparent power.
  - Harmonic analysis of voltage and current waveforms gives amplitude, phase, and total harmonic distortion results up to the 50th harmonic.
  - Triggered acquisition of digitized voltage and current with extensive post-acquisition calculations.
  - All measurements made with 16-bit resolution.
- ◆ Trigger In and Trigger Out for synchronizing transient events or measurements with external signals.
- ◆ Front panel control with 14-character vacuum fluorescent display, keypad, and rotary pulse generators for voltage and frequency settings.
- ◆ Built-in GPIB and RS-232 interface programming with SCPI command language.
- ◆ Over-voltage, over-power, over-current, over-temperature, and RI/DFI protection features.
- ◆ Built-in output and sense disconnect relays.
- ◆ Output terminals floating with respect to chassis ground.
- ◆ Extensive selftest, status reporting, and software calibration.

---

## Front Panel/Remote Operation

**The front panel** has both rotary (RPG) and keypad controls for setting the output voltage and frequency. The panel display provides digital readouts of a number of output measurements. Annunciators display the operating status of the ac source. System keys let you perform system functions such as setting the GPIB address and recalling operating states. Front panel Function keys access the ac source function menus. Front panel Entry keys let you select and enter parameter values. Refer to Chapter 4 for a complete description of the front panel controls.

**Remotely programming** is accomplished from either the GPIB bus or from an RS-232 serial port. GPIB and RS-232 programming uses SCPI commands (Standard Commands for Programmable Instruments) that make the ac source programs compatible with those of other instruments. AC source status registers permit remote monitoring of a wide variety of ac source operating conditions

**NOTE:** Refer to the ac source Programming Guide for further information about remotely programming the ac source.

## Steady-state Output Characteristic

The ac source's steady-state output characteristic is shown in the following figure. Steady-state characteristics are defined as those output ratings that will be maintained by the ac source for an indefinite time. (The section "Peak Current Capability" describes the dynamic output capability of the unit.) The figure shows both the ac and the dc characteristics. With programmable output coupling, the ac source can supply dc as well as ac output voltages.

Ac source operation is specified from 45 to 1000 Hz (see Appendix A). However, you can operate the unit at frequencies less than 45 Hz. The operating characteristics of the ac source at output frequencies below 45 Hz are documented in Table A-3 of Appendix A.

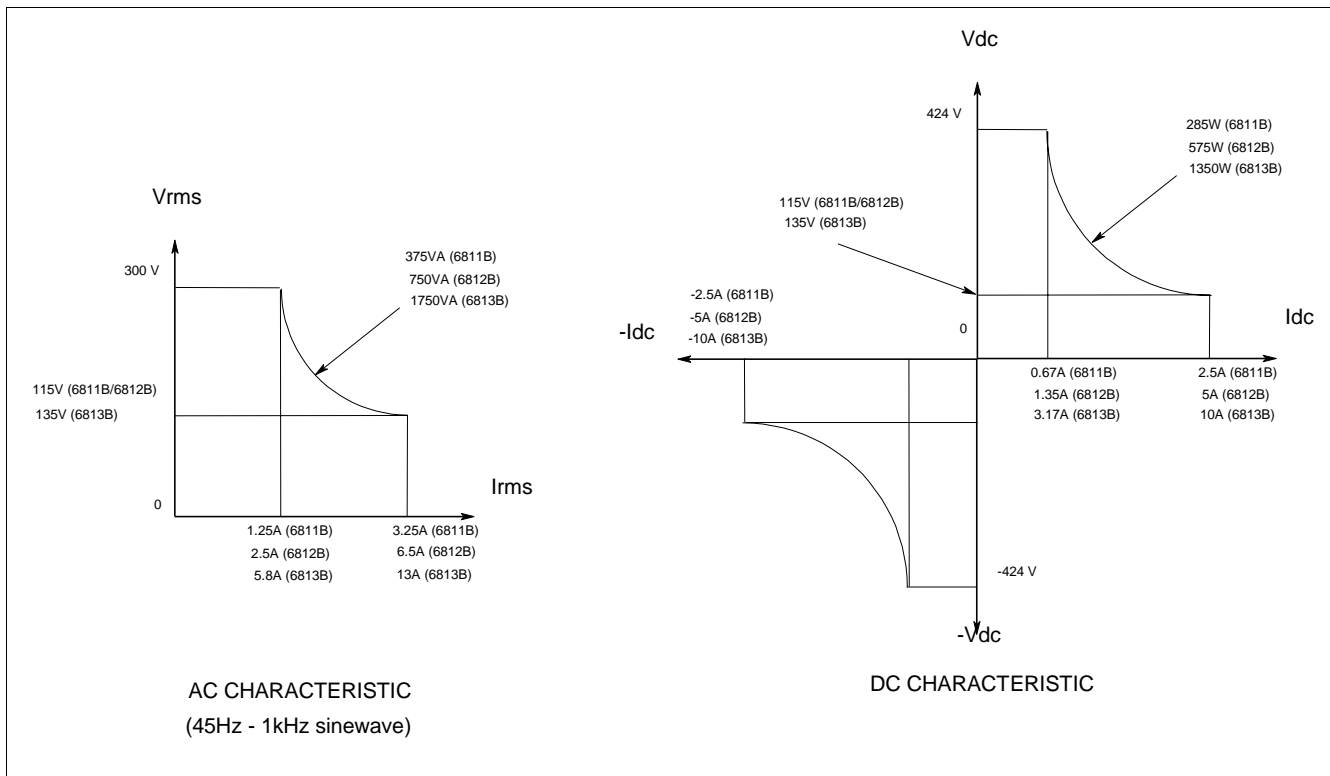

Figure 1-2. Steady-state Output Characteristic (in real-time mode)

## Peak Current/Dynamic Power Capability

The ac source can generate peak currents that exceed the rms current capability of the unit. This not only applies when operating in ac mode, but also when programming output pulses in dc mode. Although the unit will generate peak output currents up to 40A (Agilent 6811B/6812B) or 80A (Agilent 6813B), the unit can only maintain this output for a limited time. If the output of the unit exceeds the limit of the safe operating area (SOA), the unit will activate its internal protection mode and turn its output off. This SOA limit is based on output voltage, output current, output duration, and heatsink temperature.

**NOTE:** Refer to Chapter 4 on how to clear the unit when the internal protection mode has been activated.

### Peak Current Limit

By programming the peak current limit, you can prevent the unit from exceeding the safe operating area, activating its internal protection mode, and turning the output off. The peak current limit circuit limits the instantaneous output current. It functions by reducing the instantaneous output voltage to keep the output peak current within the programmed limit. Because the circuit acts instantly, the effect is that it will clip the peaks of the output voltage waveform. Additionally, with fast and/or large voltage transitions, the unit may momentarily go into CC operating mode due to current in the output capacitor. This serves to limit the rate of change of output voltage.

The following table gives approximate indications of how long the unit will tolerate peak output currents before the SOA limits are exceeded. Because these values are voltage dependent, the table includes various equivalent dc voltages along with the peak current values. The voltages shown in the table are NOT the programmed voltages, but the average voltage values that will appear at the output when the indicated high current condition exists. The SOA circuit becomes active at higher voltage and current values as well as at longer duration times.

**Table 1-3. Typical Peak Current Output Capacities**

Agilent 6813B	Agilent 6811B Agilent 6812B	equivalent dc voltage when current is flowing <sup>1</sup>					
		25	75	125	190	250	360
20 A	10 A	>100 ms	>100 ms	>100 ms	>100 ms	>100 ms	>100 ms
30 A	15 A	>100 ms	100 ms	30 ms	24 ms	19 ms	15 ms
40 A	20 A	12 ms	9.2 ms	8.4 ms	7.6 ms	6.8 ms	5.9 ms
50 A	25 A	5.6 ms	5.1 ms	4.7 ms	4.4 ms	4 ms	3.5 ms
60 A	30 A	3.7 ms	3.4 ms	3.1 ms	2.9 ms	2.6 ms	2.3 ms
70 A	35 A	2.6 ms	2.4 ms	2.2 ms	2.1 ms	1.9 ms	1.7 ms
80 A	40 A	2 ms	1.8 ms	1.7 ms	1.6 ms	1.4 ms	1.3 ms

<sup>1</sup>Based on 25C ambient temperature, with heatsink temperature less than 50C.

### Peak Inrush Example

The following table gives the recommended initial  $I_{\text{peak}}$  settings when the ac source output is a 127 Vac or 254 Vac 60 Hz sine wave, as a function of load capacitance. The load on the output is a full-wave bridge along with the indicated capacitor. The load resistance across the capacitor is infinite. The recommended  $I_{\text{peak}}$  will change as a function of changes in input as follows:



- ◆ as voltage increases, the  $I_{peak}$  setting needs to be decreased.
- ◆ as frequency increases, the  $I_{peak}$  setting can be increased.
- ◆ as load resistance decreases, the  $I_{peak}$  setting needs to be decreased.

Note that the purpose of programming the  $I_{peak}$  current is to prevent the unit from activating its internal protection mode as a result of exceeding the SOA limits, and turning the output off. These initial settings may have to be reduced if the SOA circuit trips when the output is turned on. Sometimes trial and error must be used to arrive at the proper values of  $I_{peak}$ .

**Table 1-4. Recommended  $I_{peak}$  Settings as a Function of Loop Capacitance**

Capacitance in $\mu\text{F}$		$I_{peak}$ setting
127 V	254 V	
$\leq 1100$	500	80 A
1200	-	60 A
1700	700	50 A
5000	1000	45 A
$> 5000$	$> 1000$	$< 45$ A

The following waveform illustrates the inrush current capability of the ac source. The peak current is limited during inrush in accord with table 1-3 to keep the ac source from turning its output off. Note that the output current waveform returns to its normal shape when the current drops below the peak current limit setting.

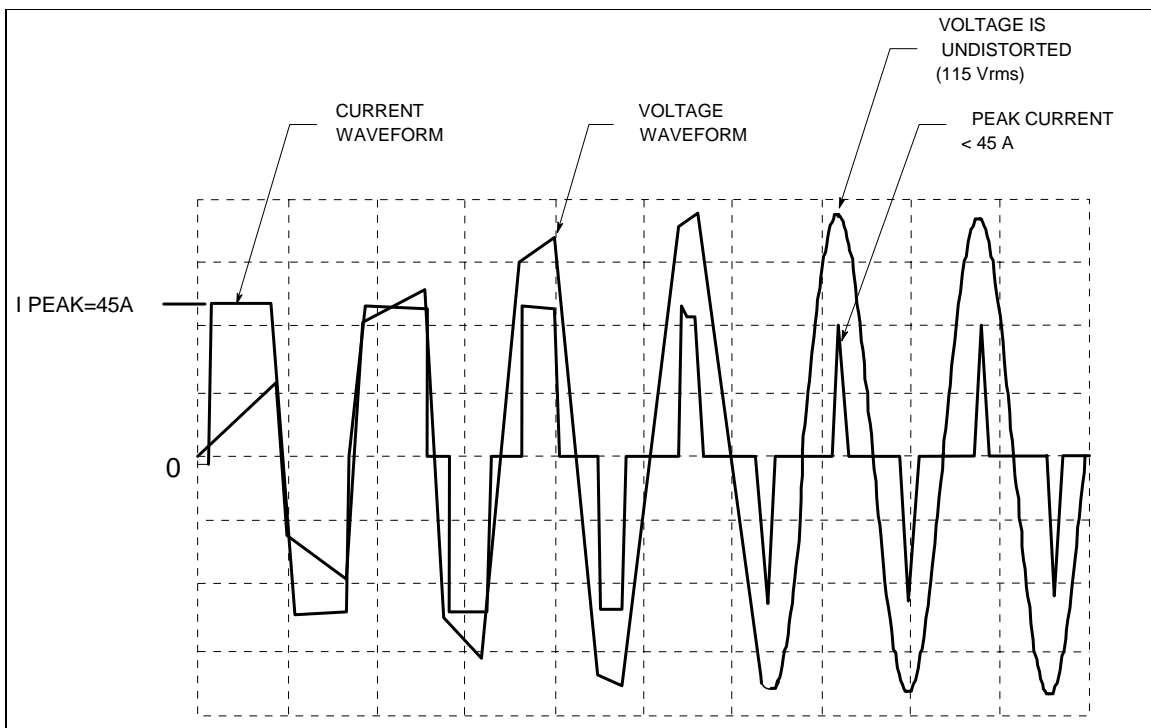

**Figure 1-3. Peak Inrush Current Example**

## RMS Current Limit Circuit

The output **rms** current limit is adjustable to any value within the range of the unit. If the load attempts to draw more current than the programmed limit, the output voltage is reduced to keep the rms current within the limit. When the output voltage is reduced, the waveform shape is preserved. In other words, all parts of the voltage cycle are reduced -- not just the peaks.

---

**NOTE:** The speed at which the rms current circuit operates depends on the output voltage setting and the load impedance. The circuit responds more slowly at low output voltages and at high output impedances. With constant power or negative resistance loads, the rms current limit circuit causes the output voltage to go to zero.

---

---

## Voltage Regulation

### Real Time Regulation

The default method of output regulation used by the ac source is real-time voltage regulation. Real-time voltage regulation tries to provide the actual programmed waveform at the output of the ac source. It offers the best overall programming response and fastest settling times. It does not have any limitations for waveforms and transients with frequency content below 45 Hz.

### RMS Regulation

Rms voltage regulation assists real-time regulation to level out or stabilize the rms value of the ac component of the output voltage. Use rms voltage regulation in the following situations:

- ◆ If you experience load regulation effects with heavy loads.
- ◆ If you experience frequency regulation problems with heavy loads and you require flatter programming accuracy at higher frequencies.
- ◆ In conjunction with programmable output impedance, if you wish to maintain the rms level of output voltage as the source impedance is increases. (Refer to Output Impedance for more information.)

The command to specify voltage regulation is `VOLT:ALC:DET RTIM | RMS`.

---

**NOTE:** Do not use rms voltage regulation when operating at frequencies less than 45 Hz.

---

---

## Output Impedance

You can program the real and/or reactive (resistive and/or inductive) part of the output impedance of the ac source. Inductive output impedances can be programmed in the range of 20 to 1000 microhenries. Resistive load impedances can be programmed in the range of 0 to 1 ohms.

When programming output impedances, the lower your load impedance, the **LESS** programmed impedance you can use and still maintain output voltage stability. This applies particularly for load impedances less than 1 ohm.

---

**CAUTION:** Programming the ac source output impedance into a load with a low impedance can cause output voltage instability, which may damage the ac source. Stability MUST be maintained when operating the ac source with programmable resistance or inductance.

To check for stability, monitor the output voltage with an oscilloscope. Instability exists if a 5kHz to 20kHz oscillation, which is dependent upon the ac source's programmed inductance and the capacitance of the load, is present at any time during the following procedure.

1. When programming inductance, it is recommended that you first add a series resistance either by programming the output resistance to 1 ohm or by adding an equivalent external resistor.
2. Slowly program the inductance to the desired level while monitoring the output for any voltage instability. Do not proceed any further if the output shows any signs of instability.
3. If less output resistance is required, slowly start lowering the resistance while monitoring the output for any voltage instability. Do not proceed any further if the output shows any signs of instability.

If you cannot achieve satisfactory results with this procedure, disable the output impedance control and use an external impedance network.

---

Rms voltage regulation can be used in conjunction with programmable output impedance to regulate the rms value of the ac component of the output voltage when programmed impedances cause distortion with nonlinear loads or reduced output voltage due to regulation effects.

Note that real-time voltage regulation will permit the load current to cause output voltage degradation based on the programmed impedance and current drawn from the source, whereas rms regulation will reestablish the rms value at the programmed level.

---

## Output Coupling

**Ac output coupling mode** mimics a transformer-coupled output, working to maintain zero average output voltage. This means that the output tries to remove any dc content on the output, whether the dc content is generated from a programmed offset or results from transients with dc content. The ac output coupling has a corner frequency of about 2 Hz, which will not prevent transient waveforms that may have short-term dc content, but will regulate the waveform back to an average value of zero volts in the steady state.

**Dc output coupling mode** is used to generate dc offset voltages or output transients that have net dc components. In either mode of operation, the maximum voltage that the ac source can output is limited to 425 V peak.

The ac capability of the output is limited by VA (volt-amperes) rather than power (watts). The amount of VA available to a load can be determined by examining figure 1-2. Full output VA is available with no limitations except for the boundaries imposed by the maximum rms voltage of 300V, and the maximum rms current, which is model-dependent. Note that large peak power transients can be delivered by the ac source as earlier described under "Peak Current Capability"(Appendix A documents the ac source's specifications and supplemental characteristics.)



## Installation

---

### Inspection

#### Damage

When you receive your ac source, inspect it for any obvious damage that may have occurred during shipment. If there is damage, notify the shipping carrier and the nearest Agilent Sales and Support Office immediately. The list of Agilent Sales and Support Offices is at the back of this guide. Warranty information is printed in the front of this guide.

#### Packaging Material

Until you have checked out the ac source, save the shipping carton and packing materials in case the unit has to be returned. If you return the ac source for service, attach a tag identifying the model number and the owner. Also include a brief description of the problem.

#### Items Supplied

Check that the following items are included with your ac source. Some items are installed in the unit.

<b>Power Cord</b>	A power cord appropriate for your location. The cord may or may not be terminated in a power plug (see "Options" in Chapter 1). If the cord is not included, contact your nearest Agilent Sales and Support Office (refer to the list at the back of this guide).
<b>Digital connector</b>	4-terminal digital plug that connects to the back of the unit.
<b>Safety covers</b>	Ac input cover with strain relief Ac output cover
<b>Manuals</b>	User's Guide Programming Guide Quick Start Guide Quick Reference Card
<b>Change page</b>	If applicable, change sheets may be included with this guide. If there are change sheets, make the indicated corrections in this guide.

#### Cleaning

Use a dry cloth or one slightly dampened with water to clean the external case parts. Do not attempt to clean internally.

---

**WARNING:** To prevent electric shock, unplug the unit before cleaning.

---

## Location

Refer to the Safety Summary page at the beginning of this manual for safety-related information about environmental conditions.

**CAUTION:** Agilent 6811B/6812B units weigh 28.2 kg (62 lbs).  
 Agilent 6813B units weigh 32.7 kg (72 lbs).  
 Obtain adequate help when moving or mounting the unit in the rack.

## Bench Operation

The outline diagram in figure 2-1 gives the dimensions of your ac source. The feet may be removed for rack mounting. Your ac source must be installed in a location that allows sufficient space at the sides and back of the unit for adequate air circulation. Minimum clearances are 1 inch (25 mm) along the sides. **Do not block the fan exhaust at the rear of the unit.**

## Rack Mounting

The ac source can be mounted in a standard 19-inch rack panel or cabinet. Rack mounting kits are available as Option 1CM or 1CP. Installation instructions are included with each rack mounting kit. **Agilent ac sources also require instrument support rails** in addition to the rack mount kit. Support rails are normally ordered with the cabinet and are not included with the rack mounting kits.

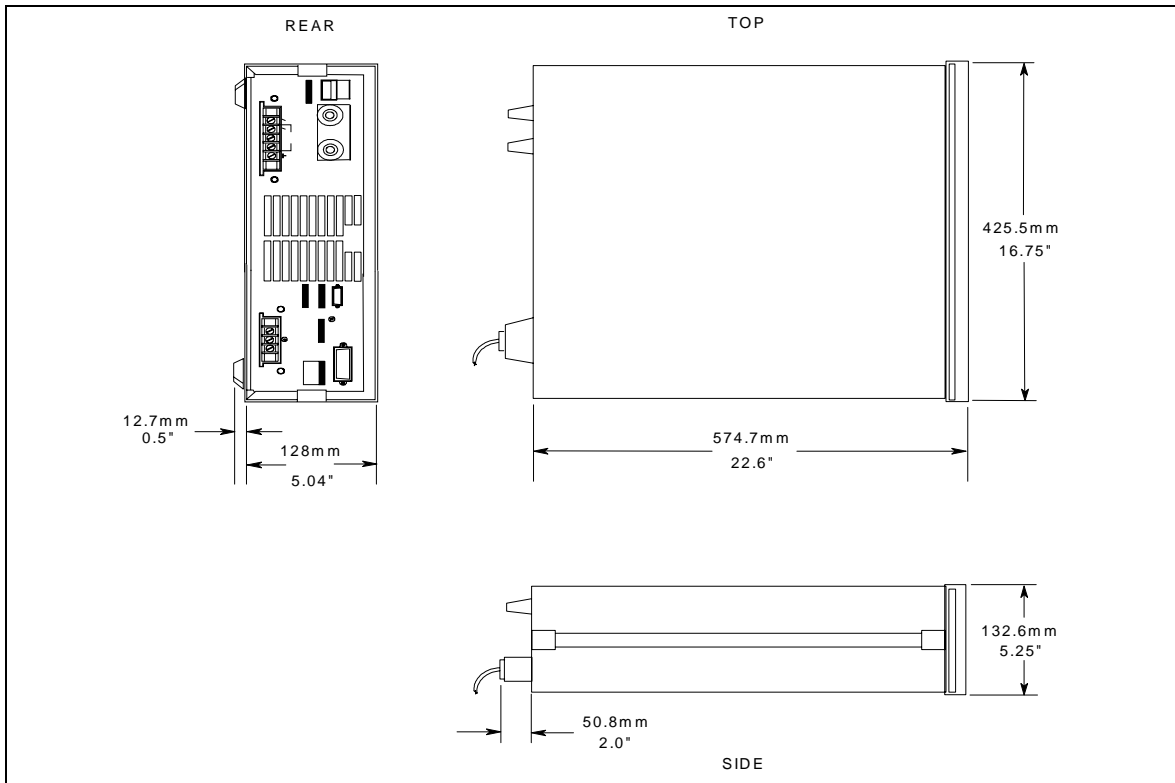

Figure 2-1. Outline Diagram

## Input Connections

### Input Source and Line Fuse

You can operate your ac source from a single-phase ac power source as indicated on the rear panel Line Rating label. See "ac Input Voltage Range" in Table A-2 of Appendix A for details.

---

**WARNING SHOCK HAZARD** The power cord provides a chassis ground through a third conductor. Be certain that your power outlet is of the three-conductor type with the correct pin connected to earth ground.

---

**NOTE:** The ac source must be on a dedicated line with no other devices consuming current from it.

---

The line fuse is located inside the ac source. Refer to "In case of Trouble" in Chapter 3 for instructions on fuse replacement.

### Installing the Power Cord

The power cord supplied with the ac source may or may not include a power plug at one end of the cord. Refer to Table 1-1 for detailed information.

**For Model 6811B**, refer to Figure 2-2 and connect the power cord to the IEC 320 connector on the rear of the unit. If your unit does not have this connector, refer to the procedure for models 6812B and 6813B.

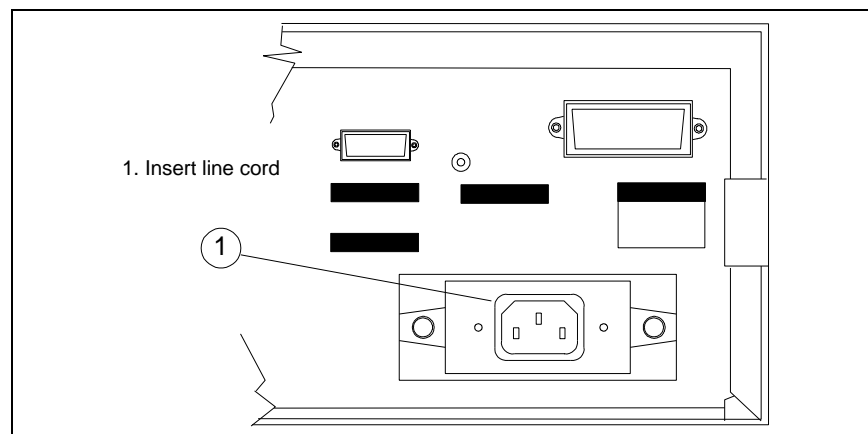

**Figure 2-2. Connecting the Power Cord (6811B)**

**For Models 6812B and 6813B**, refer to Figure 2-3 while performing the following procedure.

---

**WARNING:** Installation of the power cord must be done by a qualified and licensed electrician and must be in accordance with local electrical codes.

---

- a. If they are not already in place, position the strain relief connector (9), safety cover (5), rubber boot (8) and connector nut (7) on the power cord (6).
- b. Secure the ground wire (2) to the chassis earth ground stud.
- c. Connect the neutral wire (1) to the N power input terminal.
- d. Connect the line (3) to the L1 power input terminal.
- e. Position the safety cover over the power input terminals, tighten the cover and strain relief screws.

## 2 - Installation

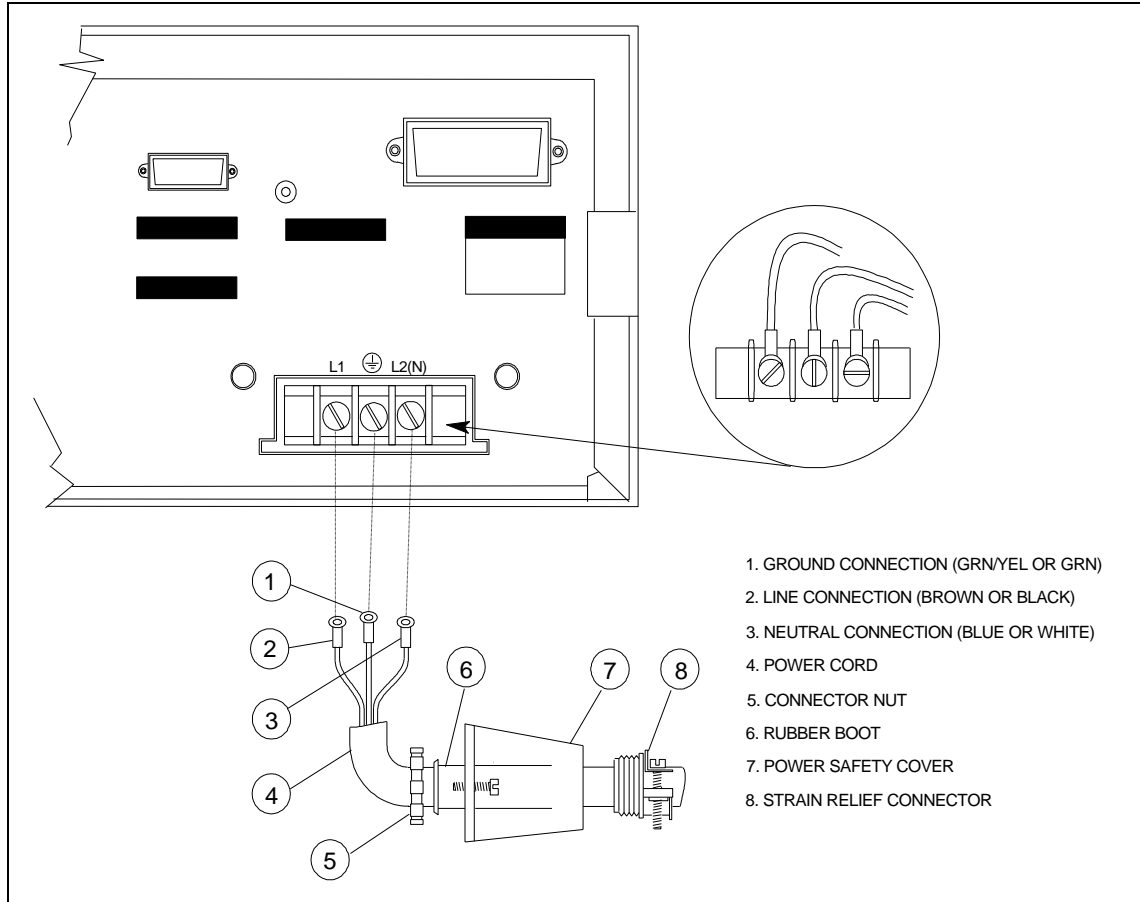

**Figure 2-3. Connecting the Power Cord (6812B, 6813B, and earlier 6811B units)**

## Output Connections

The power output terminal block has a floating output terminal connection and a floating neutral line for the return connection. A separate earth ground terminal is located on the extreme right of the terminal block.

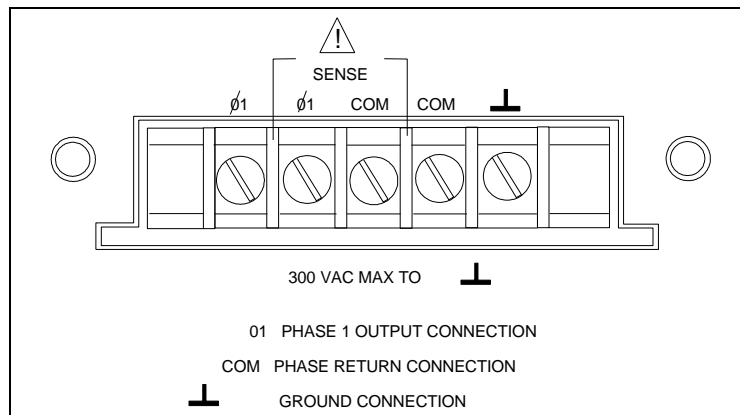

**Figure 2-4. Output Connections**



## Wire Considerations

**NOTE:** To minimize the possibility of instability on the output, keep load leads as short as possible bundle or twist the leads tightly together to minimize inductance

## Current Ratings

**Fire Hazard** To satisfy safety requirements, load wires must be large enough not to overheat when carrying the maximum short-circuit current of the ac source. If there is more than one load, then any pair of load wires must be capable of safely carrying the full-rated current of the ac source.

Table 2-1 lists the characteristics of AWG (American Wire Gage) copper wire.

**Table 2-1. Ampacity and Resistance of Stranded Copper Conductors**

AWG No.	Ampacity <sup>1</sup>	Resistance <sup>2</sup> ( $\Omega$ /m)	AWG No.	Ampacity <sup>1</sup>	Resistance <sup>2</sup> ( $\Omega$ /m)
14	25	0.0103	6	80	0.0016
12	30	0.0065	4	105	0.0010
10	40	0.0041	2	140	0.00064
8	60	0.0025	1/0	195	0.00040

**NOTES:**

1. Ampacity is based on 30°C ambient temperature with conductor rated at 60°C. For ambient temperature other than 30°C, multiply the above ampacities by the following constants:

Temp. (°C)	Constant	Temp. (°C)	Temp. (°C)
21-25	1.08	41-45	0.71
26-30	1.00	46-50	0.58
31-35	0.91	51-55	0.41
36-40	0.82		

2. Resistance is nominal at 75 °C wire temperature.

## Voltage Drops

The load wires must also be large enough to avoid excessive voltage drops due to the impedance of the wires. In general, if the wires are heavy enough to carry the maximum short circuit current without overheating, excessive voltage drops will not be a problem. Refer to Table 2-1 to calculate the voltage drop for some commonly used AWG copper wire. If load regulation becomes a problem refer to the section "Remote Sense Connections".

## Remote Sense Connections

Under normal operation, the ac source senses the output voltage at the output terminals on the back of the unit. External sense terminals are available on the **back** of the unit that allow the output voltages to be sensed at the load, compensating for impedance losses in the load wiring. As shown in the following figure:

## 2 - Installation

- ◆ Connect the phase 1 (1) sense terminals to the side of the load that connects to the corresponding output terminal.
- ◆ Connect the Neutral (COM) sense terminal connector to the neutral side of the load.
- ◆ Twist and shield all signal wires to and from the sense connectors.

The sense leads are part of the ac source's feedback path and must be kept at a low resistance in order to maintain optimal performance. Connect the sense leads carefully so that they do not become open-circuited.

---

**CAUTION:** If the sense leads are left unconnected or become open during operation, the ac source will regulate at the output terminals, but with a 40% increase in output voltage over the programmed limit. The meter circuit cannot read back this increase in output voltage when the sense lead is disconnected.

---

Set the ALC command to EXT (external) to enable remote sensing. The ALC command is located under the Voltage key as explained in Chapter 4. Set the ALC command to INT (internal) to disable remote sensing.

---

**NOTE:** If you are using external relays to connect and disconnect the load and sense connections, do NOT permit the sense connections to open when remote sensing is enabled. First disable remote sensing, then open the sense and load connections.

---

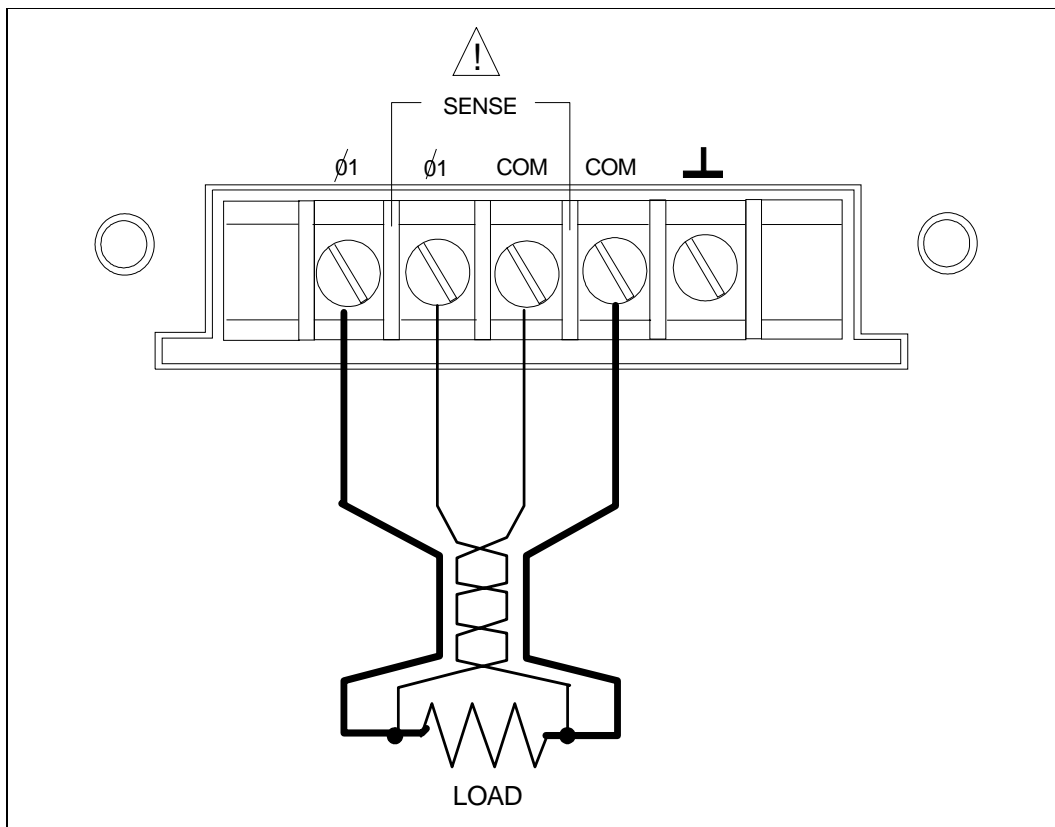

Figure 2-5. Remote Sense Connections

## Remote Sensing and OVP Considerations

In remote sense applications, the voltage drop in the load leads subtracts from the available load voltage (see "Remote Sensing Capability" in appendix A). As the ac source increases its output to overcome this voltage drop, the sum of the programmed voltage and the load-lead drop may exceed the ac source's maximum voltage rating. This may trip the OV protection circuit, which senses the voltage at the output terminals, not at the load. When using remote sensing, you must program the OVP trip voltage high enough to compensate for the voltage drop between the output terminals and the load.

---

**NOTE:** If the load causes the peak current limit circuit to become active, voltage transitions on the output may cause nuisance tripping of the OVP circuit.

---

## Trigger Connections

The BNC trigger connectors on the rear panel let you apply trigger signals to the ac source as well as generate trigger signals from the ac source. The electrical characteristics of the trigger connectors are described in appendix A. More information on programming external triggers is found in Chapter 4 of the ac source Programming Guide.

**Trigger IN** Allows negative-going external trigger signals to trigger the ac source.

**Trigger OUT** Generates a negative-going pulse when the selected transient output has occurred.

## Digital Connections

This connector, which is on the rear panel, is for connecting the fault and the inhibit signals. The fault (FLT) signal is also referred to as the DFI signal in the front panel and SCPI commands. The inhibit (INH) signal is also referred to as the RI signal in the front panel and SCPI commands.

The connector accepts wires sizes from AWG 22 to AWG 12. Disconnect the mating plug to make your wire connections. The electrical characteristics of the digital connectors are described in appendix A. More information on programming the digital connectors is found in Chapter 4 of the ac source Programming Guide.

---

**NOTE:** It is good engineering practice to twist and shield all signal wires to and from the digital connectors

---

The following examples show how you can connect the FLT/INH circuits of the ac source.

In example A, the INH input connects to a switch that shorts pin + to pin  $\perp$  whenever it is necessary to disable output of the unit. This activates the remote inhibit (RI) circuit, which turns off the ac output. The front panel Prot annunciator comes on and the RI bit is set in the Questionable Status Event register. To re-enable the unit, first open the connection between pins + and  $\perp$  and then clear the protection circuit. This can be done either from the front panel or over the GPIB/RS-232.

## 2 - Installation

In example B, the FLT output of one unit is connected to the INH input of another unit. A fault condition in one of the units will disable all of them without intervention either by the controller or external circuitry. The controller can be made aware of the fault via a service request (SRQ) generated by the Questionable Status summary bit.

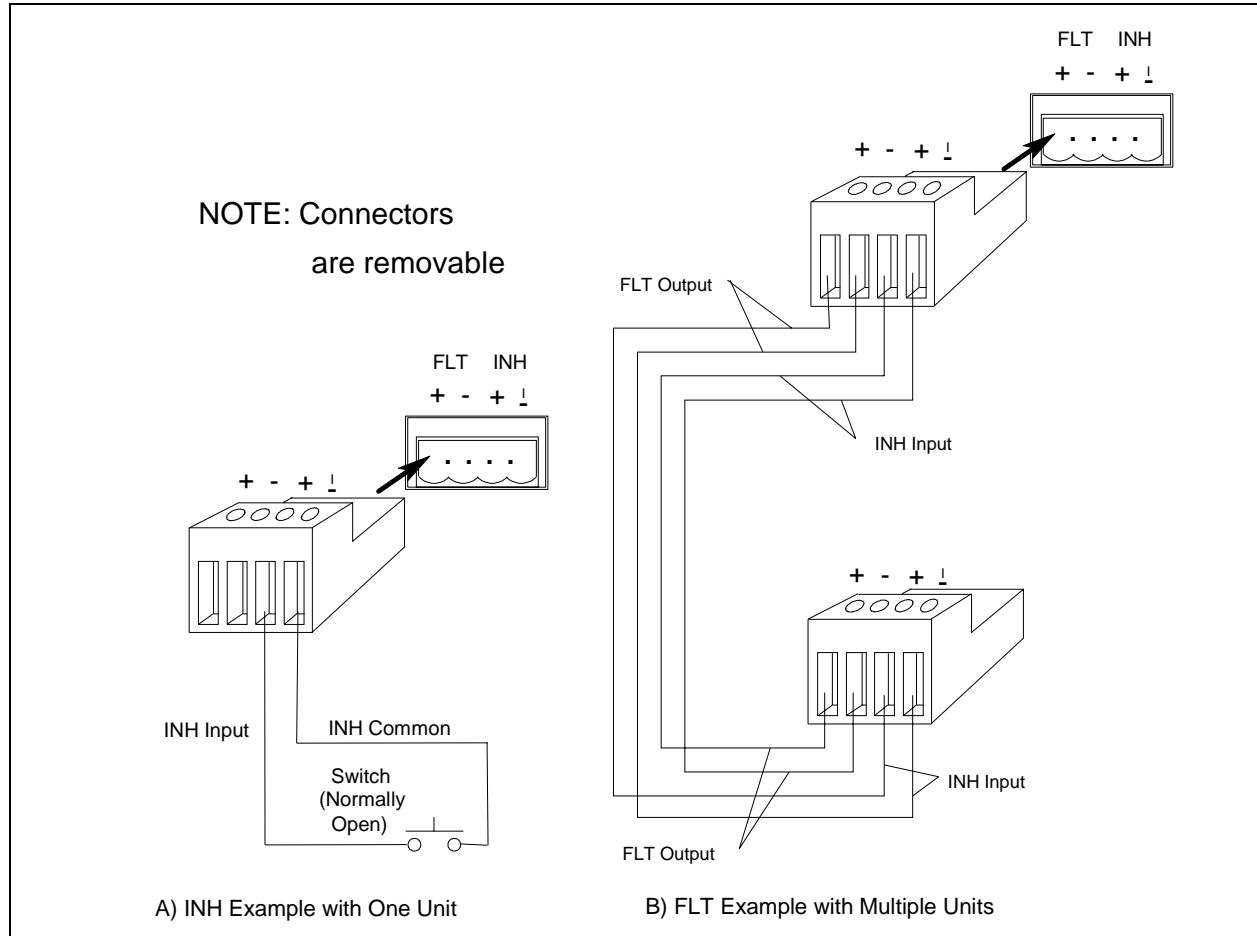

Figure 2-6. FLT/INH Examples

## Controller Connections

The ac source connects to a controller either through a GPIB or an RS-232 connector.

### GPIB Connector

Each ac source has its own GPIB bus address. AC sources may be connected to the bus in series configuration, star configuration, or a combination of the two. You may connect from 1 to 15 ac sources to a controller GPIB interface.

**NOTE:** The ac source is shipped from the factory with its GPIB address set to 5. This address can be changed as described in Chapter 4 of this guide.

## RS-232 Interface

The ac source provides an RS-232 programming interface, which is activated by commands located under the front panel Address key. When the RS-232 interface is selected, the GPIB interface is disabled.

---

**NOTE:** Sending or receiving data over the RS-232 interface when not configured for REMOTE operation can cause unpredictable results. Always make sure the ac source is configured for remote operation when using the RS-232 interface.

---

### Interface Commands

All SCPI commands are available through RS-232 programming. The SYSTEM:LOCAL, SYSTEM:REMOte, and SYSTEM:RWLock commands are only available through the RS-232 interface.

**SYSTEM:LOCAL** Places the ac source in local mode during RS-232 operation. The front panel keys are functional.

**SYSTEM:REMOte** Places the ac source in remote mode during RS-232 operation. All front panel keys except the LOCAL key are disabled.

**SYSTEM:RWLock** Places the ac source in remote mode during RS-232 operation. All front panel keys including the LOCAL key are disabled.

### RS-232 Data Format

- ◆ constant 11-bit data format
- ◆ one start bit
- ◆ seven data bits plus a parity bit (even or odd parity), or eight data bits without parity (parity bit is "0")
- ◆ two stop bits

You can specify one of the following baud rates: 300 600 1200 2400 4800 9600

---

**NOTE:** The ac source always uses one start bit and two stop bits regardless of the baud rate. The number of start and stop bits is not programmable.

---

### RS-232 Connector

The RS-232 connector is a DB-9, male connector. You can connect the ac source to any computer or terminal with a properly configured DB-25 connector. You can use a standard Agilent 24542G or 24542H interface cable.

**Table 2-2. RS-232 Connector**

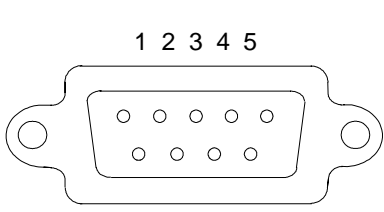
	Pin	Input/Output	Description
	1	Output	Reserved for service use
	2	Input	Receive Data (RxD)
	3	Output	Transmit Data (TxD)
	4	Output	Data Terminal Ready (DTR)
	5	Common	Signal ground
	6	Input	Data Set Ready (DSR)
	7		no connection
	8		no connection
	9	Output	Reserved for service use

## 2 - Installation

### Hardware Handshake

The RS-232 interface uses the DTR (data terminal ready) line as a holdoff signal to the bus controller. When DTR is true, the bus controller may send data to the ac source. When DTR goes false, the bus controller must stop sending data within 10 characters, and must not send any more data until DTR goes true again. The ac source sets DTR false under two conditions.

1. When the input buffer is full (approximately 100 characters have been received), it will set DTR false. When enough characters have been removed to make space in the input buffer, DTR will be set to true, unless condition 2 (see below) prevents this.
2. When the ac source wants to "talk", which means that it has processed a query, and has seen a <newline> message terminator, it will set DTR false. This implies that once a query has been sent to the power source, the bus controller should read the response before attempting to send more data. It also means that a <newline> must terminate the command string. After the response has been output, the ac source will set DTR true again, unless condition #1 prevents this.

The ac source monitors the DSR (data set ready) line to determine when the bus controller is ready to accept data. It checks this line before each character is sent, and the output is suspended if DSR is false. When DSR goes true, transmission will resume. The ac source will leave DTR false while output is suspended. A form of deadlock exists until the bus controller asserts DSR true to allow the ac source to complete the transmission.

Control-C is the equivalent to the GPIB device clear command. It clears the operation in progress and discards any pending output. For the control-C character to be recognized by the power source while it holds DTR false, the bus controller must first set DSR false.

Null modem RS-232 interface cables swap the DTR and DSR lines as shown in the following figure. For other bus controllers or languages, you must determine what form of hardware handshake is used. You may have to build a customized cable to connect the holdoff lines as necessary. If your bus controller does not use hardware handshaking, tie the DSR input to the ac source to a signal that is always true. This implies that your bus controller must always be ready to accept data. You may want to set the baud rate to either 2400 or 4800 baud to ensure that this is true.

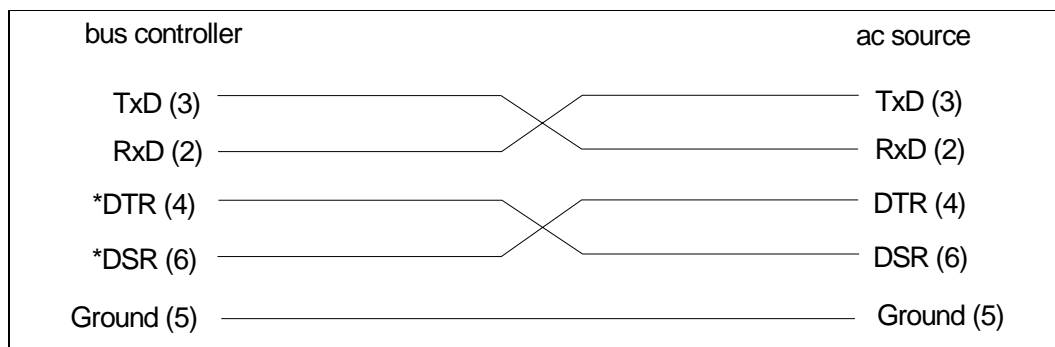

**Figure 2-7. Null Modem Interface Lines**

### Response Data Terminator

All RS-232 response data sent by the ac source is terminated by the ASCII character pair <carriage return><newline>. This differs from GPIB response data which is terminated by the single character <newline>.

## Turn-On Checkout

---

### Introduction

Successful tests in this chapter provide a high degree of confidence that the ac source is operating properly. For verification tests, see appendix B. Complete performance tests are given in the Service Guide.

---

**NOTE:** This chapter provides a preliminary introduction to the ac source front panel. See Chapter 4 for more details.

---

### Preliminary Checkout

---

**WARNING:** *LETHAL VOLTAGES.* Ac sources can supply 425 V peak at their output. **DEATH on contact may result if the output terminals or circuits connected to the output are touched when power is applied.**

---



1. If you have not already done so, connect the power cord to the ac source and plug it in.
2. Turn the front panel power switch to ON (1).
3. The ac source undergoes a self-test when you turn it on. The following items appear on the display:
  - a. A brief pattern that lights all display segments, followed by the model number and the software revision number.
  - b. The display then goes into the meter mode with the **Dis** annunciator on, and all others off. "Meter mode" means that the VOLTS digits indicate the output voltage and the FREQ digits indicate the output frequency. The voltage will be at or near zero and the frequency will be at 60 Hertz.



**Note:** If the ac source detects an error during self-test, the **Err** annunciator on the display will be lit. Pressing the **Shift** and **Error** keys will show the error number. Go to "In Case of Trouble" at the end of this chapter.
4. Check that the ac source fan is on. You should be able to hear the fan and feel the air coming from the unit.
5. Press **Output on/off** once. The Dis annunciator will go off and the CV annunciator will go on.
6. Turn the unit off.



---

## Using the Keypad

 (shift) Some of the front panel keys perform two functions, one labeled in black and the other in blue. You access the blue function by first pressing the blue shift key. Release the key after you press it. The **Shift** annunciator will be on, indicating that you have access to any key's shifted function.

 and  These keys let you scroll up and down through the choices in the presently selected function menu. All menu lists are circular; you can return to the starting position by continuously pressing either key.

 and  These keys let you select the previous or the next parameter for a specific command. If the command has a numeric range, these keys increment or decrement the existing value.

 The backspace key is an erase key. If you make a mistake entering a digit and have not yet pressed **Enter**, you can delete the digit by pressing . Delete more digits by repeatedly pressing this key.

 Executes the entered value or parameter of the presently accessed command. Until you press this key, the parameters you enter with the other keys are displayed but not entered into the ac source. After pressing **Enter**, the ac source returns to Meter mode in most cases. In Harmonic or List mode, the ac source displays the next point in the list.

---

## Checkout Procedure

**WARNING:** *LETHAL VOLTAGES.* Ac sources can supply 425 V peak at their output. DEATH on contact may result if the output terminals or circuits connected to the output are touched when power is applied.

The output test requires that you connect light bulbs to the output of the unit and apply a potentially hazardous voltage of 120 Vac. Properly shield all connections and wires.

---

The test in this section checks for output voltage and current on the ac source by having you connect light bulbs to the output of the unit. The following equipment is recommended for performing this output checkout procedure:

- ◆ 1 - 100 W light bulb
- ◆ 1 - light bulb socket
- ◆ wires for connecting socket to the unit

---

**NOTE:** When the ac source is turned on as shipped from the factory, it asserts the \*RST state. You can subsequently program the unit to turn on according to the state stored in \*RCL location 0, as explained in Chapter 4. The following procedures assume that the unit turns on in the \*RST state.

---

**Make sure that the unit is turned off**, and make the following connections to the output.



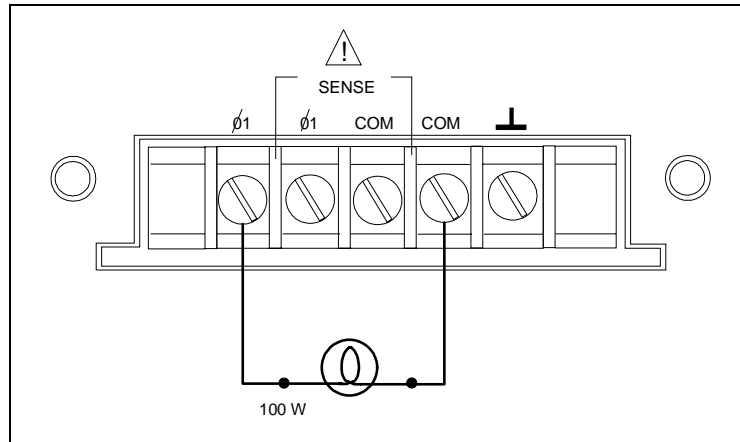

Figure 3-1.Verification Connections

Procedure	Display	Explanation
1. Turn the unit on.	Meter mode	Meter mode is active and the <b>Dis</b> annunciator should be on.
2. Press the <b>Voltage</b> key.	VOLT 0.00	Display indicates the default settings.
3. Press <b>1, 2, 0, Enter</b>	VOLT 120	Programs the output voltage to 120 Vrms. After the value is entered, the display returns to Meter mode, which indicates that no voltage is applied to the output.
4. Press <b>Output On/Off</b>	120 V 60 Hz	Turns the output on and applies 120 volts to the light bulb. The <b>Dis</b> annunciator should be off and <b>CV</b> should be on.
5. Press <b>Protect</b> , scroll to VOLT:PROT ON/OFF. Press <b>↓</b> to select ON. Then press <b>Enter</b> .	VOLT:PROT ON	You have enabled the overvoltage protection circuit.
6. Press <b>Protect</b> , scroll to the VOLT:PROT item.	VOLT:PROT 500	Display shows the overvoltage protection trip voltage for your unit. The overvoltage protection voltage is programmed in <b>peak</b> , not rms volts.
7. Press <b>1, 6, 0, Enter</b>	VOLT:PROT 160	Programs the OVP to 160 Vpeak, the rms value of which is less than the previously set rms voltage.
	0 V 60 Hz	Because the peak OVP voltage entered was less than the rms output voltage, the OVP circuit tripped. The output dropped to zero, <b>CV</b> turned off, and <b>Prot</b> turned on.
8. Press <b>Protect</b> , scroll to the VOLT:PROT item, and press <b>3, 2, 0, Enter</b>	VOLT:PROT 320	Programs the OVP to a peak value that is greater than the rms output voltage value. <b>Note:</b> You cannot clear an OVP trip until you have first removed the cause of the condition.
9. Press <b>Protect</b> , and <b>Enter</b>	120 V 60 Hz	Executes the PROT:CLEAR command, restoring the output. <b>Prot</b> turns off and <b>CV</b> turns on.

### 3 - Turn-On Checkout

	<b>Procedure</b>	<b>Display</b>	<b>Explanation</b>
10.	Press <b>Shift</b> , and <b>Current</b>	CURR:LEV 5	Indicates the default output current limit setting.
11.	Press . <b>5 Enter</b>	CURR:LEV .5	Sets the current limit to .5 amperes. The <b>CC</b> annunciator is on, indicating that the unit is in current limit mode and the light bulbs are dimmer because the output voltage has dropped in its attempt to limit output current.
12.	Press <b>Protect</b> , scroll to CURR:PROT ON/OFF. Press <b>↓</b> to select OFF, then press <b>Enter</b> .	CURR:PROT ON	You have enabled the overcurrent protection circuit. The circuit then tripped because of the output short. The <b>CC</b> annunciator turns off and the <b>OC</b> and <b>Prot</b> annunciators come on. The output current is near zero.
13.	Press <b>Output On/Off</b>	0.5 V 60 Hz	The output is off and the <b>Dis</b> annunciator turns on.
14.	Press <b>Protect</b> , scroll to CURR:PROT ON/OFF. Press <b>↓</b> to select OFF, then press <b>Enter</b> .	CURR:PROT OFF	You have disabled the overcurrent protection circuit. The <b>Prot</b> annunciator turns off.
15.	Turn the unit off.		The next time the unit turns on it will be restored to the *RST or factory default state

---

## In Case of Trouble

### Error Messages

Ac source failure may occur during power-on selftest or during operation. In either case, the display may show an error message that indicates the reason for the failure.

### Selftest Errors

Pressing the **Shift** and **Error** keys will show the error number. Selftest error messages appear as: ERROR <n>, where "n" is a number listed in the following table. If this occurs, turn the power off and then back on to see if the error persists. If the error message persists, the ac source requires service.

**Table 3-1. Power-On Selftest Errors**

<b>Error No.</b>	<b>Failed Test</b>
Error 0	No error
Error 1	Non-volatile RAM RD0 section checksum failed
Error 2	Non-volatile RAM CONFIG section checksum failed
Error 3	Non-volatile RAM CAL section checksum failed
Error 4	Non-volatile RAM WAVEFORM section checksum failed
Error 5	Non-volatile RAM STATE section checksum failed
Error 6	Non-volatile RAM LIST section checksum failed
Error 10	RAM selftest
Error 11 to 18	DAC selftest 1 to 8

### Runtime Error Messages

Under unusual operating conditions, the front panel display may show **OVLD**. This indicates that the output voltage or current is beyond the range of the meter readback circuit. If the front panel display indicates `-----`, a GPIB measurement is in progress. Appendix C lists other error messages that may appear at runtime.

### Line Fuse

If the ac source appears "dead" with a blank display and the fan not running, first check your power source to be certain line voltage is being supplied to the ac source. If the power source is normal, the ac source line fuse may be defective. If the ac source has a defective fuse, replace it only once. If it fails again, investigate the reason for the failure. Proceed as follows:

---

**WARNING:** Hazardous voltages can remain active inside the ac source even after it has been turned off. Fuse replacement should be done only by a qualified electronics technician.

---

The line fuse is located inside the ac source. To change it, refer to Figure 3-2 and proceed as follows:

1. Turn off the front panel power switch and unplug the line cord from the ac source.
2. Remove the ac cover as follows:
  - a. Remove the four screws securing the carrying straps and dustcover (use a T25 Torx drive).
  - b. Spread the bottom rear of the cover and pull it back to remove it.
3. Observe the two LEDs on each side of the unit. If either LED is ON, there is still hazardous voltages present inside the ac source. Wait until the LEDs are out before proceeding (it may take several minutes for the LEDs to go out.)
4. Replace the fuse with one of the same type. Do not use a slow-blow type fuse
5. Replace the cover.
6. Connect the line cord to the ac source.
7. Turn on power and verify operation.

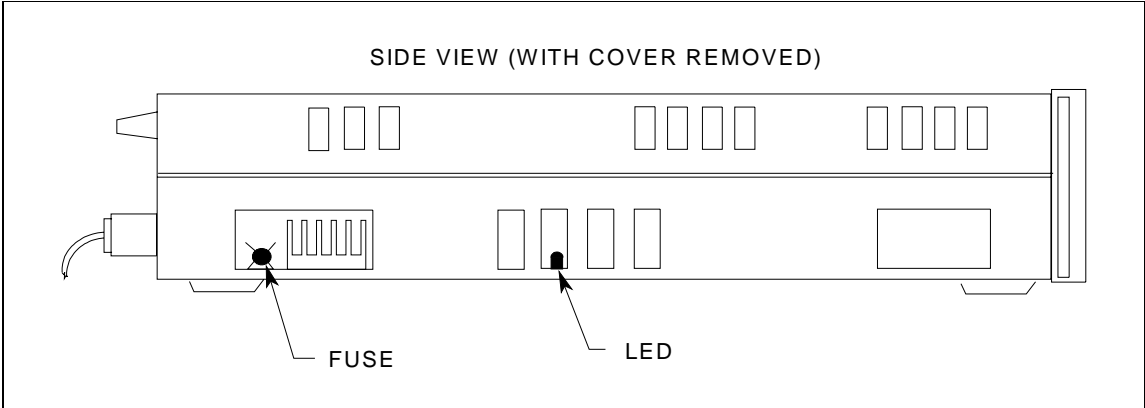

**Figure 3-2. AC Source Fuse Location**



## Front panel Operation

### Introduction

Here is what you will find in this chapter:

- ◆ a complete description of the front panel controls
- ◆ front panel programming examples that describe:
  - how to program the output voltage and frequency
  - how to measure the output
  - how to program the output pulses and lists
  - how to trigger output changes

### Front Panel Description

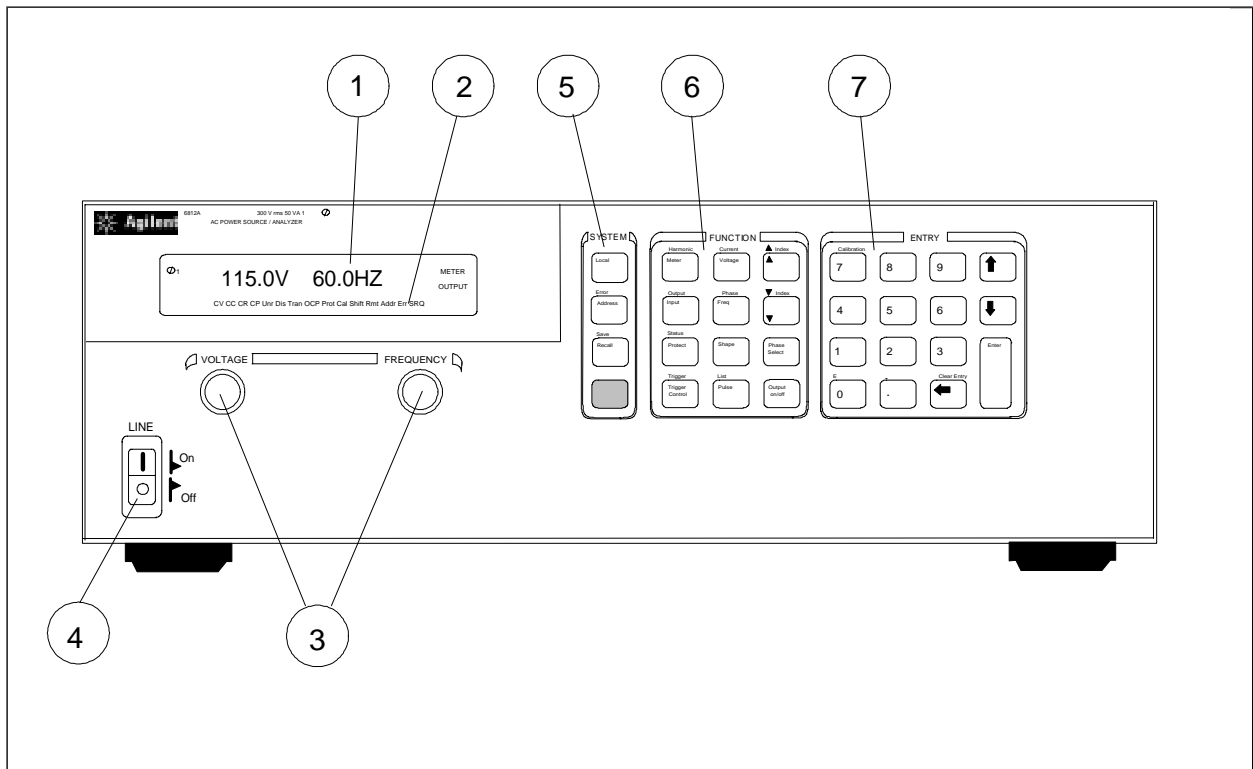

Figure 4-1. Front Panel, Overall View

## 4 - Front Panel Operation

- ① **Display** 14-character vacuum fluorescent display for showing programmed commands and measured values.
- ② **Annunciators** Annunciators light to indicate operating modes and status conditions:
- φ1** Phase 1 is being controlled or metered.
  - CV** The ac source output is in constant-voltage mode.
  - CC** The ac source output is in constant-current mode.
  - Unr** The ac source output is in an unregulated state.
  - Dis** The ac source output is disabled (off).
  - Tran** The ac source output is initialized to output a transient.
  - OCP** The overcurrent protection state is enabled.
  - Prot** One of the ac source's output protection features is activated.
  - Cal** The ac source is in calibration mode.
  - Shift** The Shift key is pressed to access an alternate key function.
  - Rmt** The selected interface (GPIB or RS-232) is in a remote state.
  - Addr** The interface is addressed to talk or to listen.
  - Err** There is a message in the SCPI error queue.
  - SRQ** The interface is requesting service from the controller.
  - Meter** Front panel measurement functions are: ac only, dc only, or ac+dc
- AC+DC**
- Output** The ac source output coupling is: ac only, or ac+dc
- AC+DC**
- ③ **Voltage/  
Frequency** The rotary pulse generators let you set the output voltage and frequency when the ac source is in local mode. Their response is rate sensitive.
- Turning a control rapidly provides coarse control of the value.
  - Turning a control slowly provides fine control of the value.
- ⑤ **Line** This turns the ac source on or off.
- ⑥ **System Keys** The system keys let you:
- Return to Local mode (front panel control)
  - Set the ac source GPIB address
  - Set the RS-232 interface communication baud rate and parity bit
  - Display SCPI error codes and clear the error queue
  - Save and recall up to 4 instrument operating configurations
- ⑦ **Function Keys** Function access command menus that let you:
- Program output voltage, current limit, frequency, and output waveforms
  - Turn the output on and off
  - Select metering functions
  - Send immediate triggers from the front panel
  - Program transient output functions
  - Set and clear protection functions
  - Select output phases
  - Select the coupling for output and meter functions
  - Monitor instrument status
- ⑧ **Entry Keys** Entry keys let you:
- Enter programming values
  - Increment or decrement programming values
  - Calibrate the ac source

## System Keys

Refer to the examples later in this chapter for more details on the use of these keys.

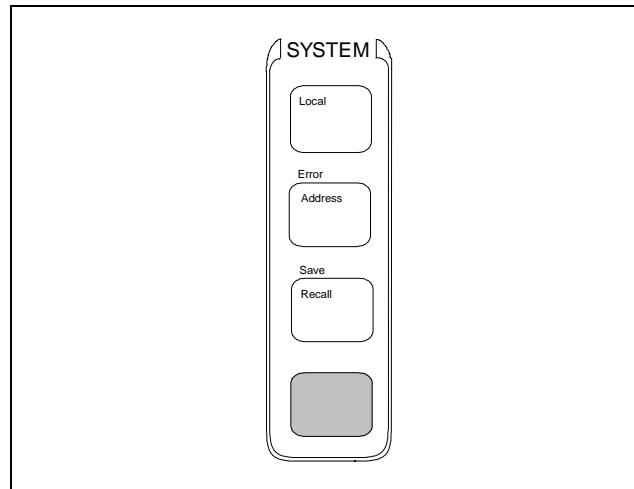

**Figure 4-2. System Keys**



This is the blue, unlabeled key, which is also shown as  in this guide. Pressing this key accesses the alternate or shifted function of a key (such as **ERROR**). Release the key after you press it. The **Shift** annunciator is lit, indicating that the shifted keys are active.



Press to change the ac source's selected interface from remote operation to local (front panel) operation. Pressing the key will have no effect if the interface state is already Local, Local-with-Lockout, or Remote-with-Lockout.







Press to access the system address menu. This menu lets you configure the ac source's interface. Address Menu entries are stored in non-volatile memory.

<b>Display</b>	<b>Command Function</b>
ADDRESS <value>	Sets the GPIB Address
INTF <char>	Selects an interface (GPIB or RS232)
BAUDRATE<value>	Selects baud rate (300, 600, 1200, 2400, 4800, 9600)
PARITY <char>	Message parity (NONE, EVEN, ODD, MARK, SPACE)
LANG <char>	Selects language (SCPI or E9012)

value = a numeric value

char = a character string parameter

Use  and  to scroll through the command list.

Use  and  to scroll through the parameter list.



Press to place the ac source into a previously stored state. You can recall up to 16 (0 through 15) previously stored states.



Press to display the system error codes stored in the SCPI error queue. This action also clears the queue. If there is no error in the queue, 0 is displayed.



Press to store an existing ac source state in non-volatile memory. The parameters saved are listed under \*SAV in the ac source Programming Guide. You can save up to 16 states (0 through 15).

## Function Keys

Refer to the examples later in this chapter for more details on the use of these keys.

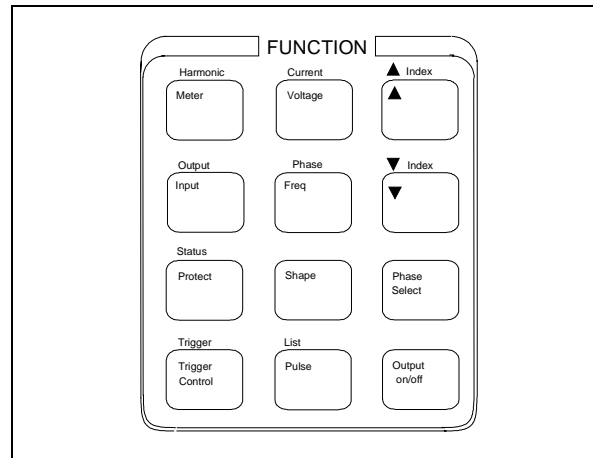

Figure 4-3. Function Keys

### Immediate Action Keys

Immediate action keys **immediately** execute their corresponding function when pressed. Other function keys have commands underneath them that are accessed when the key is pressed.

Output  
On/Off

This key toggles the output of the ac source between the on and off states. It immediately executes its function as soon as you press it. When off, the ac source output is disabled and the **Dis** annunciator is on.

Phase  
Select

This key only applies to three-phase ac sources

Shift Trigger

Sends an immediate trigger to the ac source

### Scrolling Keys

Scrolling keys let you move through the commands in the presently selected function menu.

▲ ▼

These scroll keys let you move through the choices in a command list. Press ▼ to bring up the next command in the list. Press ▲ to go back to the previous command in the list. Function menus are circular; you can return to the starting position by continuously pressing either key. The following example shows the commands in the Input function menu:

Shift ▲Index

These shifted scroll keys apply only to the Harmonic and List functions.

Shift ▼Index

Press these keys to step through integers 0 through 50 when specifying the desired harmonic number, or 0 through 99 when specifying the desired list point. Hold down these keys to rapidly access any harmonic or list point.

↑ ↓

These Entry keys let you scroll through choices in a **parameter** list that apply to a specific command. Parameter lists are circular; you can return to the starting position by continuously pressing either key. If the command has a numeric range, these keys increment or decrement the existing value.



## Meter Display Keys

Metering keys control the metering functions of the ac source.

**Meter**

Press this key to access the meter menu list.

### Display

<reading>V <reading>Hz  
 <reading>V <reading>A  
 <reading>A <reading>Hz  
 <reading>V <reading>W  
 <reading> CREST F  
 <reading>A PK REP  
 <reading>A PK NR  
 <reading> VA  
 <reading> VAR  
 <reading> PFACTOR

### Measurement

rms voltage and frequency (the default)  
 rms voltage and rms current  
 rms current and frequency (the default)  
 rms voltage and power  
 current crest factor  
 peak current, repetitive  
 peak current, nonrepetitive<sup>1</sup>  
 apparent power  
 reactive power  
 power factor

**Input**

Press this key to specify the following metering functions.

### Display

INP:COUP <char>  
 CURR:RANGE <char>  
  
 WINDOW <char>

### Command Function

Choose meter coupling (AC, DC or ACDC)  
 Current measurement range (HIGH or LOW)  
 HIGH = for measuring rms currents > 5.7 A  
 LOW = for measuring rms currents < 5.7 A  
 Select harmonic measurement window meter  
 (KBESSEL, RECT)

**Shift**

**Harmonic**

Press this key to access the harmonic menu list

### Display

<reading>A I:MAG: <index>  
 <reading>° I:PHASE: <index>  
 <reading>V V:MAG: <index>  
 <reading>° V:PHASE: <index>  
 <reading> N:MAG: <index>  
 <reading>° N:PHASE: <index>  
 <reading>° CURR:THD  
 <reading>° VOLT:THD

### Measurement

current harmonic magnitude  
 current harmonic phase  
 voltage harmonic magnitude  
 voltage harmonic phase  
 neutral current harmonic magnitude  
 neutral current harmonic phase  
 current total % harmonic distortion  
 voltage total % harmonic distortion

### Notes:

<sup>1</sup>Displays the highest peak current since it was last cleared. The value is cleared when you scroll into this selection or press **Enter** or **Clear Entry**

reading = the returned measurement

index = a numeric value that represents the harmonic number from 0 to 50

char = a character string parameter

**▲** and **▼** scroll through the command list.

**↑** and **↓** scroll through the parameter list.

**▲Index** and **▼Index** specify the desired harmonic.

## 4 - Front Panel Operation

### Output Control Keys

Output control keys control the output functions of the ac source.

**Voltage**

Press this key to access the voltage menu list.

#### Display

VOLT <value>

VOLT:T<value>

VOLT:M <char>

OFFSET <value>

OFFSET:T<value>

OFFSET:M <char>

SLEW <value>

SLEW:T<value>

SLEW:M <char>

OFF:SLW <value>

OFF:SLW:T<value>

OFF:SLW:M <char>

ALC <char>

ALC:DET <char>

#### Command Function

Set immediate rms output voltage

Set triggered rms output voltage

Select the voltage mode (FIXED, STEP, PULSE or LIST)

Set immediate dc offset voltage

Set triggered dc offset voltage

Select the dc offset voltage mode (FIXED, STEP, PULSE or LIST)

Set immediate voltage slew rate in volts/second

Set triggered voltage slew rate in volts/second

Select the voltage slew mode (FIXED, STEP, PULSE or LIST)

Set immediate dc offset voltage slew in volts/second

Set triggered dc offset voltage slew in volts/second

Select the dc offset voltage slew mode (FIXED, STEP, PULSE or LIST)

Select the voltage sense source (INT or EXT)

Select the voltage sense detector (RTIME or RMS)

**Shift**

**Current**

Press this key to access the current menu list.

#### Display

CURR:LEV <value>

CURR:PEAK <value>

CURR:PEAK:T <value>

CURR:PEAK:M <value>

#### Command Function

Set immediate rms output current limit

Set immediate peak output current limit

Set triggered peak output current limit

Select the peak output current limit mode (FIXED, STEP, PULSE or LIST)

**Freq**

Press this key to access the frequency menu list.

#### Display

FREQ <value>

FREQ:T<value>

FREQ:M <char>

SLEW <value>

SLEW:T<value>

SLEW:M <char>

#### Command Function

Set immediate output frequency

Set triggered output frequency

Select the frequency mode (FIXED, STEP, PULSE or LIST)

Set immediate frequency slew rate in volts/second



Set triggered frequency slew rate in volts/second



Select the frequency slew mode (FIXED, STEP, PULSE or LIST)

#### Notes:

value = a numeric value

char = a character string parameter

 and  scroll through the command list.

 and  scroll through the parameter list.

Shift

Phase

Press this key to access the phase menu list.

<b>Display</b>	<b>Command Function</b>
PHASE <value>	Set immediate output phase
PHASE:T <value>	Set triggered output phase
PHASE:M <char>	Select the phase mode (FIXED, STEP, PULSE or LIST)

Shape

Press this key to access the shape menu list.

<b>Display</b>	<b>Command Function</b>
SHAPE <char>	Select the immediate output wave shape (SINE, SQUARE, or CSINE) CSIN = clipped sine wave
SHAPE:T <char>	Select the triggered output wave shape (SINE, SQUARE, or CSINE) CSIN = clipped sine wave
SHAPE:M <char>	Select the shape mode (FIXED, STEP, PULSE or LIST)
CLIP <value>	Set the clipping level of the CSIN wave shape. This specifies the point where clipping starts as a percentage of the peak amplitude or percentage of THD.

Pulse

Press this key to access the pulse menu list.

<b>Display</b>	<b>Command Function</b>
WIDTH <value>	Set the pulse width
COUNT <value>	Set the number of output pulses
DCYCLE <value>	Set the pulse duty cycle as a percentage of the pulse period
PER <value>	Set the pulse period
HOLD <char>	Set the parameter that will be held constant as the other parameters change (WIDTH or DCYCLE)

Shift

Output



Press this key to access the output menu list.



<b>Display</b>	<b>Command Function</b>
OUTP:COUP <char>	Select output coupling (AC or DC)
*RST	Execute *RST command to place the ac source in the factory-default state
TTLT:SOUR <char>	Select Trigger Out source coupling (BOT, EOT or LIST) BOT = beginning of transient EOT = end of transient LIST = TTLT trigger (see Programming Guide)
TTLT:STATE <value>	Set Trigger Out state (ON or OFF)
IMP:STATE <value>	Set output impedance programming (ON or OFF)
IMP:REAL <value>	Set real part of output impedance
IMP:REAC <value>	Set reactive part of output impedance
PON:STATE <char>	Select power-on state command (RST or RCL0)
RI <char>	Sets remote inhibit mode (LATCHING, LIVE, or OFF)
DFI <char>	Sets discrete fault indicator state (ON or OFF)
DFI:SOUR <char>	Select the DFI source (QUES, OPER, ESB, RQS, or OFF) (see Chapter 4 of Programming Guide)

**Notes:**

value = a numeric value

char = a character string parameter

 and  scroll through the command list.

 and  scroll through the parameter list.

## 4 - Front Panel Operation

### Protection and Status Control Keys

The Protect and Status keys control the protection functions and status registers of the ac source. Refer to Chapter 4 of the Programming guide for more information on the status registers.

**Protect**

Press this key to access the protection menu list.

#### Display

PROT: CLEAR

CURR: PROT <char>

VOLT: PROT <value>

DELAY <value>

#### Command Function

Clear the status registers of all activated protection signals. The fault causing a signal must be corrected or removed before the register can be cleared.

Set overcurrent protection function (ON or OFF).

Set the overvoltage protection level<sup>1</sup>

Set the time delay for activating a protection fault after programming the output

**Shift**

**Status**

Press this key to access the status menu list. Note that in the following list, commands ending in ? clear the registers when they are read. For this reason the registers are read only after you press **Enter**, not when you scroll to the command

#### Display

\*CLS

STATUS: PRESET

\*ESR? <value>

\*STB <value>

OPER: EVEN? <value>

OPER: COND <value>

QUES: EVEN? <value>

QUES: COND <value>

#### Command Function

Executes the clear status (\*CLS) command

Execute the STATUS: PRESet command

Return Event Status register value

Return Status Byte register value

Return STAT: OPER: EVENT? value

Return STAT: OPER: COND? value

Return STAT: QUES: EVENT? value



Return STAT: QUES: COND? value



#### Notes:

<sup>1</sup>Programmed in peak volts. (Other voltage parameters are programmed in rms volts)

value = a numeric value

char = a character string parameter

 and  scroll through the command list.

 and  scroll through the parameter list.

## Trigger and List Control Keys

The Trigger Control key controls output transient triggers. The List key controls the generation of output lists. A list can contain up to 100 points, each of which can specify an output change (or transient). Refer to Chapter 4 of the Programming Guide for more information about programming triggers and lists.

Trigger  
Control

Press this key to access the trigger control menu list.

### Display

INIT:IMMED  
INIT:CONT <char>  
TRIG:SOUR <char>

DELAY <value>  
ABORT  
SYNC:SOUR <char>  
SYNC:PHASE <value>

### Command Function

Initiate the transient trigger sequence immediately.  
Set continuous trigger initiation (ON or OFF).  
Select transient trigger source (BUS, EXT, TTLT or IMM).  
Set trigger delay in seconds.  
Abort all trigger sequences.  
Select trigger sync source (PHASE or IMM).  
Set synchronous phase reference angle in degrees.

Shift

List

Press this key to access the list commands

### Display

COUNT <value>  
DWEL:<index> <value>  
FREQ:<index> <value>  
FSLW:<index> <value>  
IPK:<index> <value>  
OFFS:<index> <value>  
OSLW:<index> <value>  
PHASE:<index> <value>  
SHAP:<index> <char>

STEP<char>  
TTLT:<index> <value>  
VOLT:<index> <value>  
VSLW:<index> <value>

### Command Function

Specifies the number of times a list repeats.  
List of output dwell times.  
List of output frequencies.  
List of output frequency slew rates  
List of output peak current limits.  
List of dc output voltages.  
Dc offset voltage slew rate list  
List of output voltage phase angles.  
List of output waveform shapes.<sup>1</sup>  
(SINE, SQUARE or CSIN) CSIN = clipped sine wave  
Response of list to triggers (ONCE or AUTO).  
List of Trigger Out pulses (0=no pulse; 1=pulse).  
List of ac output voltages.  
List of output voltage slew rates.

### Notes:

<sup>1</sup>User-defined waveshapes will also appear in this list when created.

value = a numeric value

char = a character string parameter

index = a numeric value that represents a list point from 0 to 99

▲ and ▼ scroll through the command list.

↑ and ↓ scroll through the parameter list.

▲Index and ▼Index scroll through the desired list points. EOL is displayed when the end of the list is reached. When a value is edited, pressing Enter automatically advances to the next list point. Pressing Clear Entry truncates or clears the list at the presently displayed list point.

## Entry Keys

Refer to the examples later in this chapter for more details on the use of these keys.

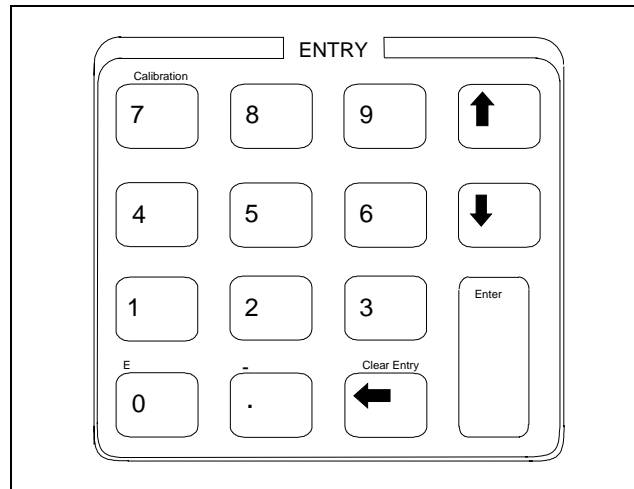
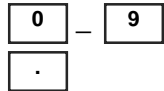

Figure 4-4. Entry Keys



These keys let you scroll through choices in a **parameter** list that apply to a specific command. Parameter lists are circular; you can return to the starting position by continuously pressing either key. If the command has a numeric range, these keys increment or decrement the existing value.



**0** through **9** are used for entering numeric values. **.** is the decimal point. For example, to enter 33.6 press: **3 3 . 6 Enter**.



The backspace key deletes the last digit entered from the keypad. This key lets you correct one or more wrong digits before they are entered.



This key executes the entered value or parameter of the presently accessed command. Until you press this key, the parameters you enter with the other Entry keys are displayed but not entered into the ac source. Before pressing **Enter** you can change or abort anything previously entered into the display. After Enter is pressed, the ac source returns to Meter mode in most cases. In Harmonic or List mode, the ac source displays the next point in the list.



This key specifies an exponential power of 10. For example, the the value for 100µs can be entered as either **. 0 0 0 1** , or as **1 E - 4**



This key **-** is the minus sign.

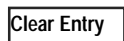

This key aborts a keypad entry by clearing the value. This key is convenient for correcting a wrong value or aborting a value entry. The display then returns to the previously set function. **When editing a list**, pressing **Clear Entry** truncates or clears the list at the presently displayed list point.

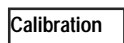

This key accesses the calibration menu (Refer to Appendix B to calibrate your ac source).

## Examples of Front Panel Programming

You will find these examples on the following pages:

- 1 Setting the output voltage amplitude
- 2 Setting the output frequency
- 3 Setting the dc offset
- 4 Setting a protection feature
- 5 Clearing a protection feature
- 6 Generating step, pulse, and list transients
- 7 Programming trigger delays and phase synchronization
- 8 Programming slew rates
- 9 Measuring peak inrush current
- 10 Setting the GPIB address or RS-232 parameters
- 11 Saving and recalling operating states

The examples in the ac source Programming Guide are similar to the ones in this section, except that they use SCPI commands.

### 1 - Setting the Output Voltage Amplitude

**NOTE:** The maximum voltage that the ac source can output is limited by the peak value of the waveform, which is  $425 V_{\text{peak}}$ . Since the output is programmed in units of rms volts, the maximum value that can be programmed is dependent on the peak-to-rms ratio of the selected waveform. For a sinewave, the maximum ac voltage that can be programmed is  $300 V_{\text{rms}}$ . For other waveforms the maximum may be different.

When you turn on the ac source, the default output shape is a 60 Hz sinewave at 0 Vrms. There is no output from the ac source because the default output state is OFF, as indicated by the **Dis** annunciator.

**Set the output to 120 V rms as follows:**

Action	Display
<b>You can set the voltage in any of three ways:</b>	
1. On the Function keypad, press <b>Voltage</b> . On the Entry keypad, press <b>1 2 0 Enter</b> . This is the easiest way to enter an accurate value.	VOLT 120
2. On the Function keypad, press <b>Voltage</b> . On the Entry keypad, press <b>▲</b> or <b>▼</b> to increment or decrement the existing value. This technique is useful when you are making minor changes to an existing value.	VOLT 127
3. Rotate the front panel <b>Voltage</b> knob to obtain 120 V. This method is best when you want to enter a value without using the voltage menu.	120 V 60 Hz

**Note:** You will not see the new voltage on the front panel meter unless the output is enabled.

**To enable the output:**

- |   |             |
|---|-------------|
| 4. On the Function keypad, press <b>Output On/Off</b> . The <b>Dis</b> annunciator will go off, indicating that the voltage is now applied to the output terminals. | 120 V 60 Hz |
|---|-------------|

## 4 - Front Panel Operation

### 2 - Setting the Output Frequency

When you turn on the ac source, the default output frequency is a 60 Hz. Assuming the voltage output from example 1 is in effect (120 V<sub>rms</sub> sinewave), **change the frequency to 50 Hz as follows:**

Action	Display
<b>You can set the frequency in the same way that you set the voltage:</b>	
1. On the Function keypad, press <b>Freq.</b> On the Entry keypad, press <b>5 0 Enter.</b>	FREQ 50
2. On the Function keypad, press <b>Freq.</b> On the Entry keypad, press <b>▲</b> or <b>▼</b> to increment or decrement the existing value.	FREQ 50
3. Rotate the front panel <b>Frequency</b> knob to obtain 50 Hz.	FREQ 50
<b>To verify the output, use the meter menu:</b>	
4. The Meter menu is presently displaying the measured voltage and frequency of the selected output phase. Press <b>▲</b> and <b>▼</b> to scroll through all of the measurement functions in the Meter Menu.	120 V 50 Hz

### 3 - Setting the DC Offset

---

**NOTE:** Because the maximum voltage that the ac source can output is limited to 425 V<sub>peak</sub>, you cannot program a dc offset that will cause a previously programmed ac voltage to exceed the 425 V<sub>peak</sub> limit ( $ac_{peak} + offset \leq 425 \text{ V}$ ).

---

The dc output capability of the ac source lets you independently control the dc and ac components of the output voltage. **Program a dc offset of 100 V as follows:**

Action	Display
1. On the Function keypad, press <b>Voltage</b> and then press <b>▼</b> until you access the OFFSET command.	OFFSET 0
2. On the Entry keypad, press <b>1 0 0 Enter.</b>	OFFSET 100
3. On the Function keypad, press <b>Shift Output</b> to access the output coupling command.	OUTP:COUP AC
<b>Note:</b> When the output coupling is set to ac, the ac source regulates the dc output voltage to 0, regardless of any programmed voltage offset.	
4. Press <b>▼</b> and <b>Enter</b> to change the output coupling to DC.	OUTP:COUP DC
5. The ac source output now combines the previously programmed ac rms voltage and the dc offset voltage. This is indicated by the <b>OUTPUT AC+DC</b> annunciator. The front panel meter is measuring a 120 V <sub>rms</sub> sinewave offset by 100 Vdc. This is indicated by the <b>METER AC+DC</b> annunciator.	156 V 50 Hz

**To measure just the ac or just the dc portion of the output:**

6. On the Function keypad, press <b>Input</b> to access the metering functions.	INP:COUP ACDC
7. Press <b>▼</b> until you access the <b>DC</b> parameter and press <b>Enter</b> . This changes the metering function to dc, which measures just the dc portion of the output in volts. The meter annunciator indicates <b>METER AC</b>	INP:COUP DC 100 V 50 Hz
8. Press <b>Input</b> again. Press <b>▼</b> until you access <b>AC</b> and press <b>Enter</b> . This changes the metering function to ac, which measures just the ac portion of the output in rms volts. The meter annunciator indicates <b>METER DC</b>	INP:COUP AC 120 V 50 Hz



## 4 - Setting a Protection Feature

You can set the ac source to disable its output if it detects an overvoltage or overcurrent fault condition. Other automatic fault conditions (such as overtemperature) also will disable the output. **Set the overcurrent protection feature as follows:**

- | <b>Action</b>   | <b>Display</b> |
|---|----------------|
| 1. On the Function keypad, press <b>Protect</b> .   | PROT:CLEAR     |
| 2. Press <b>↓</b> to obtain the overcurrent command.  | CURR:PROT OFF  |
| 3. On the Entry keypad, press <b>once</b> to scroll to the ON parameter and press <b>Enter</b> . The OCP annunciator will light, indicating that the overcurrent protection circuit is on.<br>CURR:PROT ON                | CURR:PROT ON   |
| If you wish to set a time delay between the detection of the fault and the disabling of the output, scroll to the delay command on the protection menu. The default delay is 100 milliseconds.                            | DELAY .1       |
| Enter the delay from the Entry keypad, such as <b>. 2 5 0 Enter</b> .   | DELAY .250     |
| 4. When you want to restore normal operation <b>after the cause of the overcurrent condition has been removed</b> , scroll to the protection clear command and press <b>Enter</b> . The OCP annunciator then will go off. | PROT:CLEAR     |

## 5 - Clearing Protection Conditions

When the output **Prot** annunciator is on, the output of the ac source has turned off due to one or more of the following conditions:

Annunciator	Description	Bit Number	Bit Weight
OV	overvoltage protection has tripped	0	1
OCP	rms overcurrent protection has tripped	1	2
SOA	safe operating area has tripped	2	4
OT	overtemperature protection has tripped	4	16
RI	an external remote inhibit signal has occurred	9	512
Rail	rail protection has tripped	11	2048

- | <b>Action</b>   | <b>Display</b> |
|---|----------------|
| 1. You must first identify the cause of the protection shutdown, and then eliminate its cause before you can continue operating the unit. |                |
| 2. To identify the problem, press <b>Shift Status</b> .   | *CLS           |
| 3. Press <b>▼</b> to obtain the Questionable Event command.   | QUES:EVEN?     |
| 4. Press <b>Enter</b> to find out which bits have been set in the Event Register.   | QUES:EVEN 20   |

**Note:** The value returned is the sum of all of the binary weights of the bits that have been set. For example, a value of 20 indicates that bit 2 (bit weight=4) and bit 4 (bit weight=16) have been set. Refer to the previous table for the bits and bit weights that are assigned to the protection conditions. Refer to the following table for information on eliminating the cause of the protection condition. Refer to Chapter 4 in the ac source Programming Guide for a complete discussion of the status system.

## 4 - Front Panel Operation

Condition	Action
<b>OV Condition</b>	<p>Usually overvoltage conditions are caused by an external source forcing voltage into the output of the ac source. Remove this external source to eliminate the overvoltage. You can also program the overvoltage level to a higher value, or turn the overvoltage protection off.</p> <p>In other cases the output voltage may have exceeded the user-programmed overvoltage level. In this case the unit may have inadvertently been programmed to a voltage that exceeded the programmed overvoltage level. The <code>VOLTage:PROTection</code> command sets the overvoltage protection level.</p> <p><b>Note:</b> The overvoltage protection level is programmed in peak, not rms volts.</p>
<b>OCP Condition</b>	<p>If the <code>CURRent:PROTection:STATe</code> command has been programmed to to disable the output when rms current limit is activated, the unit will shut down. The rms current limit threshold is set by the <code>CURRent</code> command. In this case you must check to see why the load is drawing more current than the limit that has been programmed by the <code>CURRent</code> command.</p>
<b>SOA Condition</b>	<p>Protection circuits in the ac source let the load draw peak currents for short periods of time that exceed the continuous capability of the unit. This allows loads that require large inrush currents to turn on. The ac source will shut down if a combination of peak current duration and internal component temperature exceeds a predetermined limit.</p> <p>When this occurs, it means that the load has been drawing peak output currents that are beyond the capability of the ac source to supply for extended periods. Slower output slew rates and reduced peak current limit settings can be used to control the conditions that cause SOA shutdowns.</p>
<b>OT Condition</b>	<p>When the internal operating temperatures of the ac source exceed predetermined thresholds, the output turns off. If this happens, you must let the unit cool down before continuing operation.</p>
<b>RI Condition</b>	<p>If the Remote Inhibit input has been programmed to to disable the output when it receives an external signal, the unit will shut down. The Remote Inhibit input is set by the <code>OUTPut:RI:MODE</code> command. In this case you must check to what external event produced a signal on the RI input.</p>
<b>Rail Condition</b>	<p>The internal high voltage rail that provides power for the ac source's output is continuously monitored for proper voltage level. If this voltage is not maintained within predetermined levels, the output will shut down. This can happen if an external source forces too much power into the ac source or if too much power is drawn from the ac source.</p> <p>Remove the external source to eliminate the rail condition. Slower output slew rates and reduced peak current limit settings can also be used to control the conditions that cause rail shutdowns.</p>

## 6 - Using Transient Voltage Modes

The ac source voltage can be programmed in the following transient operating modes:

- STEP causes the output to permanently change to its triggered value.
- PULSE causes the output to change to its triggered value for a specific time, as determined by the Pulse menu parameters.
- LIST causes the output to sequence through a number of values, as determined by points entered in the List menu.
- FIXED disables transient operation for the selected function.

## Step Transient

The Voltage Menu lets you specify an alternate or triggered voltage level that the ac source will apply to the output when it receives a trigger. Because the default transient voltage level is zero volts, you must first enter a triggered voltage before you can trigger the ac source to change the output amplitude. Refer to Chapter 4 of the Programming Guide for more information about programming triggers.

In the following example, **the voltage output is set to 120 Vrms and then stepped down to 102 Vrms.**

Action	Display
1. On the Function keypad, press <b>Output On/Off</b> to enable the output. The <b>Dis</b> annunciator will go off.	0 V 60 Hz
2. Press <b>Voltage</b> to access the Voltage Menu. On the Entry keypad, press <b>1 2 0 Enter</b> .	VOLT 120
3. Access the Voltage Menu again and press <b>▼</b> to access the triggered voltage command.	VOLT:T 0
4. On the Entry keypad, press <b>1 0 2 Enter</b> .	VOLT:T 102
5. Access the Voltage Menu again and press <b>▼</b> to access the voltage mode command. It should be in the default FIXED mode. An ac source function in the FIXED mode does not respond to triggers. On the Entry keypad, press <b>▲</b> or <b>▼</b> to scroll through the mode parameters. When you have STEP, press <b>Enter</b> .	VOLT:M STEP
6. Press <b>Trigger Control</b> and <b>Enter</b> . This initiates (or enables) one immediate trigger action.	INIT:IMMED
7. Press <b>Shift Trigger</b> . This sends the ac source an immediate trigger signal to change the output voltage. The triggered voltage value now becomes the VOLT value.	102 V 60 Hz

## Pulse Transient

In the following example, the output is four 83.3-millisecond, 120 Vrms pulses at 60 Hz. The figure shows the trigger, pulse count, pulse period, and duty cycle.

---

**NOTE:** From the Output Menu, execute the \*RST command to reset the ac source. This is necessary because any previously programmed functions remain in effect until cleared.

---

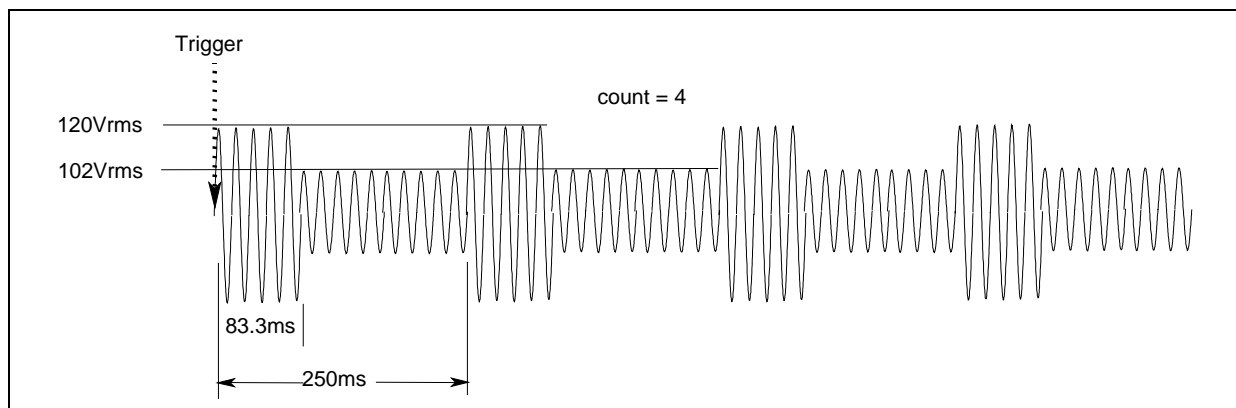

**Figure 4-5. Pulse Transients**

## 4 - Front Panel Operation

Action	Display
1. Press <b>Voltage</b> to access the Voltage Menu. On the Entry keypad, press <b>1 0 2 Enter</b> .	VOLT 102
2. Press <b>▼</b> to access the triggered voltage command. On the Entry keypad, press <b>1 2 0 Enter</b> .	VOLT 120
3. Access the Voltage Menu again and press <b>▼</b> to access the voltage mode command. On the Entry keypad, press <b>▲</b> or <b>▼</b> to scroll through the mode parameters to obtain PULSE and press <b>Enter</b> .	VOLT:M PULSE
4. Press <b>Pulse</b> to access the Pulse Menu. From the Entry keypad, press <b>. 0 8 3 3 Enter</b> to enter a pulse width of 83.3 milliseconds.	WIDTH .0833
5. Access the Pulse Menu and press <b>▼</b> to access the duty cycle command. From the Entry keypad, press <b>3 3 Enter</b> to change the duty cycle to 33%.	DCYCLE 33
6. Access the Pulse Menu and press <b>▼</b> to access the pulse count. On the Entry keypad, press <b>4</b> and <b>Enter</b> .	COUNT 4
7. Press <b>Trigger Control</b> and <b>Enter</b> to initiate the transient trigger sequence.	INIT:IMMED
8. Press <b>Shift Trigger</b> . This sends the ac source an immediate trigger signal to generate the four output pulses.	102 V 60 HZ

**Note:** The ac source output returns to 102 V at the completion of the output pulses.

### List Transient

Lists are the most flexible means of generating multiple or synchronized transient outputs. The following figure shows a voltage output generated from a list. The output shown represents three different ac voltage pulses (160 volts for 33 milliseconds, 120 volts for 83 milliseconds, and 80 volts for 150 milliseconds) separated by 67-millisecond, 0-volt intervals.

The list specifies the pulses as three voltage points (point 0, 2, and 4), each with its corresponding dwell point. The intervals are three zero-voltage points (point 1, 3, and 5) of equal intervals. The count parameter causes the list to execute twice when started by a single trigger.

**NOTE:** From the Output Menu, execute the \*RST command to reset the ac source. This is necessary because any previously programmed functions remain in effect until cleared.

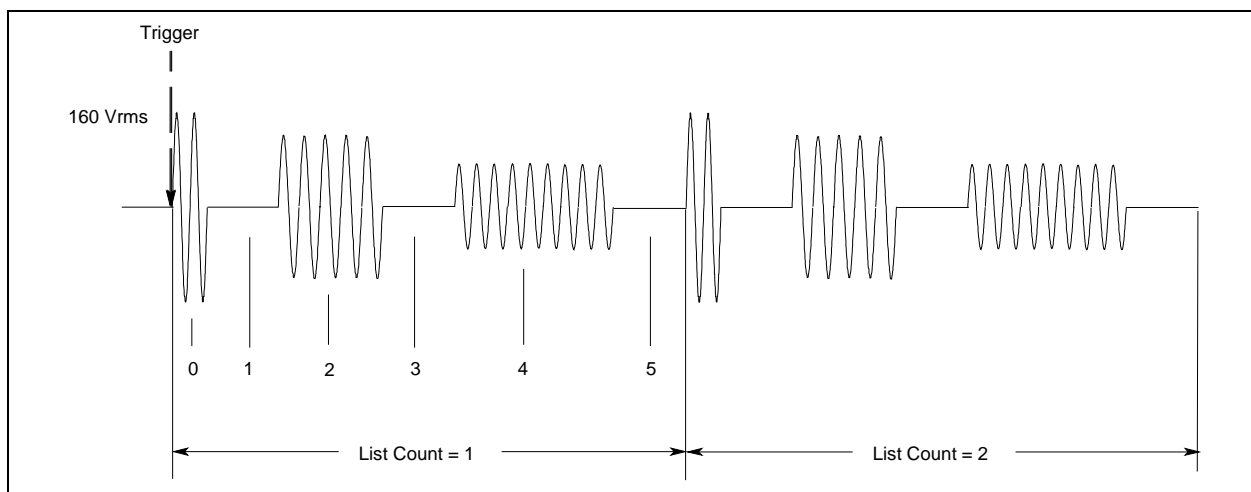

**Figure 4-6. List Transients**

<b>Action</b>	<b>Display</b>
1. Press <b>Voltage</b> to access the Voltage Menu. Then press ▼ to access the voltage mode command.	VOLT:M FIXED
2. On the Entry keypad, press ▲ or ▼ to scroll through the mode parameters to obtain LIST and press <b>Enter</b> .	VOLT:M LIST
3. Access the List Menu by pressing <b>Shift List</b> . The first menu command is the count. From the Entry keypad, change the list count from the default (1) to 2. Press <b>Enter</b> .	COUNT 2
4. Access the List menu again and press ▼ until you access the dwell time. This specifies the "on" time for each voltage point, which is effectively the output pulse width. The first dwell point (0) appears in the display. On the Entry keypad, press <b>. 0 3 3</b> and <b>Enter</b> .	DWEL 0 .033
5. Pressing the Enter key automatically advances to the step in the list. Enter the following values for dwell list points 1 through 5: .067, .083, .067, .150, .067. Press <b>Enter</b> to enter each value. When you finish, you will be at point 6, which is the end of the list.	DWEL 1 .067 DWEL 2 .083 DWEL 3 .067 DWEL 4 .150 DWEL 5 .067 DWEL 6 EOL
<b>Note:</b> Press <b>Shift ▲Index</b> or <b>Shift ▼Index</b> to access and edit any list point.	
6. Press ▼ until you access the voltage list. This specifies the amplitude of each output point during its corresponding dwell period. The first voltage list point (0) appears in the display. On the Entry keypad, press <b>1 6 0</b> and <b>Enter</b> .	VOLT 0 160
7. Pressing the Enter key automatically advances to the step in the list. Enter the following values for voltage list points 1 through 5: 0, 120, 0, 80, 0. Press <b>Enter</b> to enter each value. When you finish, you will be at point 6, which is the end of the list.	VOLT 1 0 VOLT 2 120 VOLT 3 0 VOLT 4 80 VOLT 5 0 VOLT 6 EOL
<b>Note:</b> Press <b>Shift ▲Index</b> or <b>Shift ▼Index</b> to access and edit any list point.	
8. Press ▼ until you access the step command. Check that it is at the default mode (AUTO). This lets a single trigger run your list for the specified count.	STEP AUTO
9. Press <b>Output On/Off</b> to enable the output. The <b>Dis</b> annunciator will go off.	0 V 60 Hz
10. Press <b>Trigger Control</b> and <b>Enter</b> to initiate the transient trigger sequence.	INIT:IMMED
11. Press <b>Shift Trigger</b> . This sends the ac source an immediate trigger to generate the four output pulses. The output returns to the immediate value at the end of the list.	0 V 60 Hz
<b>Note:</b> To clear a list, press <b>Clear Entry</b> . This truncates or clears the list at the presently displayed list point. Each list must be accessed and cleared separately.	

## 7 - Trigger Delays and Phase Synchronization

The ac source trigger system also lets you program trigger delays as well as synchronize output changes to a specific phase angle of the output waveform.

In example ①, the output transient is triggered immediately at the receipt of the trigger signal. In example ②, a delay time of approximately 16.7 milliseconds elapses between the occurrence of the trigger and the start of the output transient. In example ③, the trigger source is programmed for phase synchronization, which means that the transient occurs at the first occurrence of the specified phase angle after the trigger signal is received.

## 4 - Front Panel Operation

Note that phase synchronization is referenced to an internal phase signal. The output of the unit is normally offset by  $0^\circ$  with respect to this internal reference. Because synchronized transient events always occur with respect to the internal reference, the output will normally be in phase with the value programmed for phase synchronization. (The Phase command can be used to change the offset of the output with respect to the internal phase reference.)

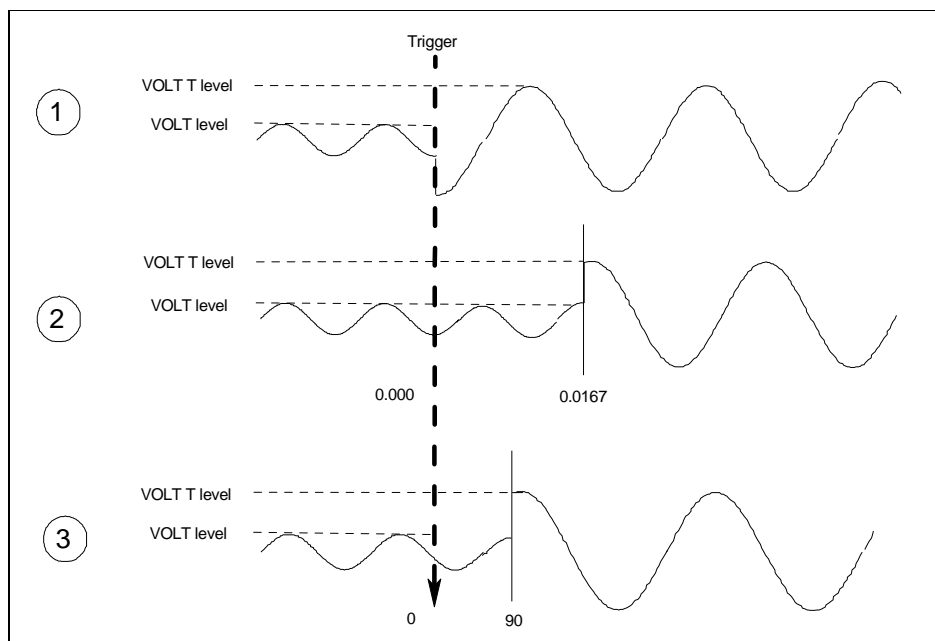

**Figure 4-7. Trigger Delays and Phase Synchronization**

### Example

- ① This example uses the default trigger parameters. First, access the Voltage menu and program the immediate and triggered voltage levels, followed by the voltage transient mode.

Then press **Trigger Control** and **Enter**, followed by **Shift Trigger**.

- ② In this example, you will set a trigger delay. First, access the Voltage menu and program the immediate and triggered voltage levels, followed by the voltage transient mode.

Press **Trigger Control**. Then press  $\blacktriangledown$  until you access the delay parameter. On the Entry keypad, press **. 0 1 6 7 Enter**.

Then press **Trigger Control** and **Enter**, followed by **Shift Trigger**.

- ③ This example uses the phase sync mode with no delay, but synchronized at  $90^\circ$ . First, access the Voltage menu and program the immediate and triggered voltage levels, followed by the voltage transient mode.

Press **Trigger Control**. Press  $\blacktriangledown$  until you access the delay parameter. If necessary, set it to 0. Press  $\blacktriangledown$  until you access the sync source command. On the Entry keypad, press  $\blacktriangledown$  to obtain PHASE. Press **Enter**.

Access the Trigger Control menu again and press  $\blacktriangledown$  to access the sync phase reference parameter. On the Entry keypad, program a  $90^\circ$  phase reference by entering **9 0 Enter**.

Then press **Trigger Control** and **Enter**, followed by **Shift Trigger**.

### Display

```
VOLT 120
VOLT:T 150
VOLT:M STEP
```

```
INIT:IMMED
```

```
VOLT 120
VOLT:T 150
VOLT:M STEP
```

```
DELAY 0
DELAY .0167
```

```
INIT:IMMED
```

```
VOLT 120
VOLT:T 150
VOLT:M STEP
```

```
DELAY 0
SYNC:SOUR PHASE
```

```
SYNC:PHAS 90
```

```
INIT:IMMED
```

## 8 - Using Slew Rates to Generate Waveforms

As shown in the previous examples there are a number of ways that you can generate custom waveforms. Programmable slew rates provide additional flexibility when customizing waveforms. The following figure illustrates how programmable slew rates are applied in the transient operating modes.

In example ①, an immediate slew rate of 50 volts/second is used whenever a new output voltage is programmed. In example ②, a triggered slew rate of 50 volts/second steps the voltage level to its new value. 50 volts/second becomes the new immediate slew rate in step mode. In example ③, a triggered slew rate of 50 volts/second is used at the start of the pulse. The immediate slew rate of infinity applies at the trailing edge of the pulse. In example ④, the slew rates are set by the values in the voltage slew list.

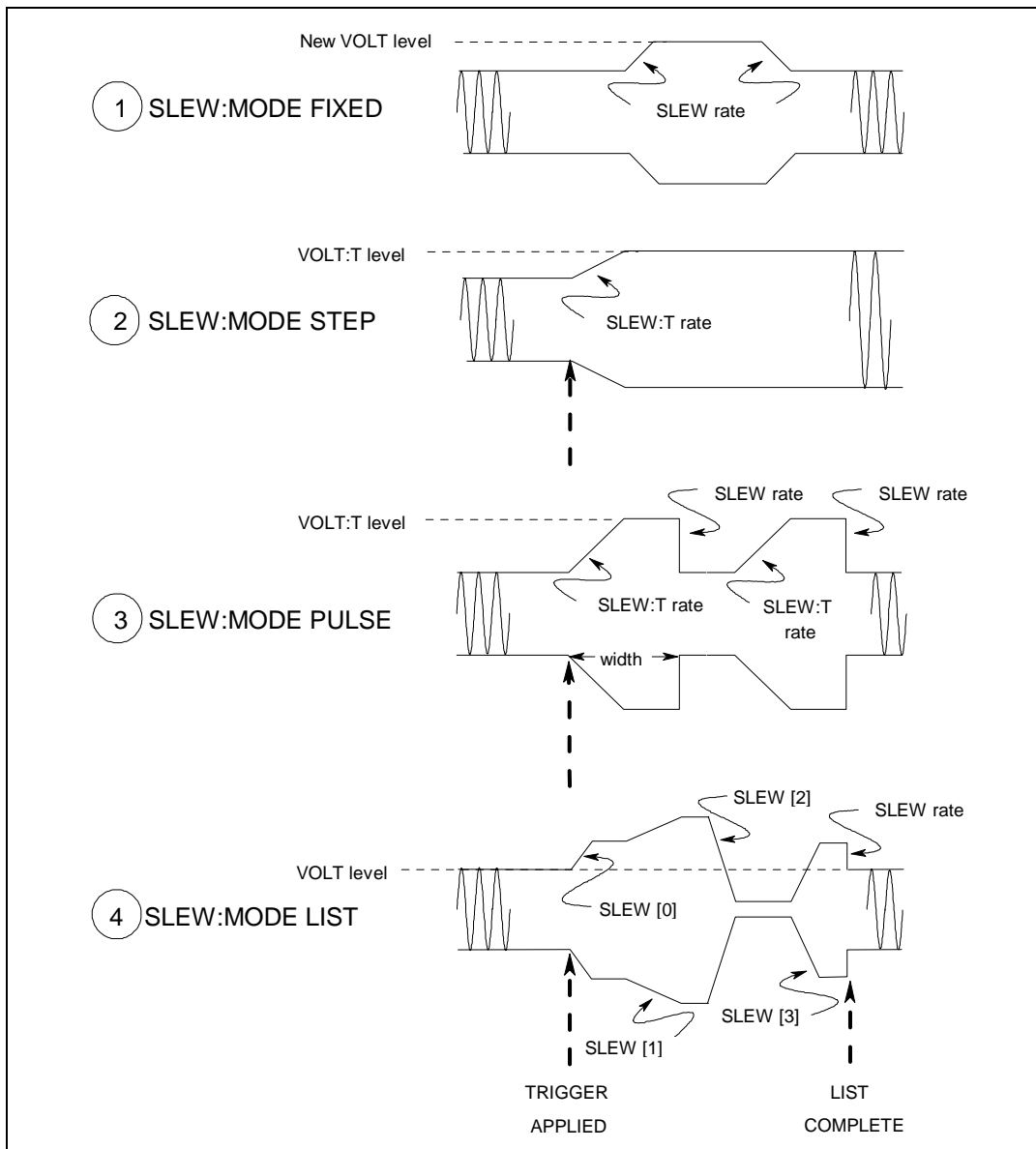

Figure 4-8. Programming Slew Rates

## 4 - Front Panel Operation

### Example

- ① This example uses the immediate slew rate. First, access the Voltage menu and press ▼ until you access the mode command. On the Entry keypad, press ↓ to obtain FIXED. Press **Enter**.

Access the voltage menu and press ▼ until you access the slew command. On the Entry keypad, press **5 0 Enter** to program a slew rate of 50 volts/second.

Whenever a new immediate voltage value is entered, the output will slew to the new level at 50 volts/second.

- ② Step mode uses the triggered slew rate. First, access the Voltage menu, program the immediate and triggered voltage levels, and set the slew mode to STEP.

Access the Voltage menu and press ▼ to access the immediate slew command. On the Entry keypad, enter a value that equals infinity.

Access the Voltage menu and press ▼ until you access the triggered slew command. On the Entry keypad, enter a value such as **5 0 Enter**, which sets the triggered slew rate to 50 volts/second.

Then press **Trigger Control** and **Enter**, followed by **Shift Trigger**.

After the trigger has been sent, in step mode, the triggered value becomes the new immediate value.

- ③ Pulse mode uses the triggered slew rate at the leading edge of the pulse, and the immediate slew rate at the trailing edge of the pulse. First, access the Voltage menu, program the immediate and triggered voltage levels, and set the slew mode to PULSE.

Access the Pulse menu and program the pulse count, duty cycle, and pulse period.

Access the Voltage menu and press ▼ to access the immediate slew command. On the Entry keypad, enter a value that equals infinity.

Access the Voltage menu and press ▼ until you access the triggered slew command. On the Entry keypad, enter a value such as **5 0 Enter**, which sets the triggered slew rate to 50 volts/second.

Then press **Trigger Control** and **Enter**, followed by **Shift Trigger**.

- ④ When the voltage slew mode is set to LIST, the slew rates are set by the values in the voltage slew list. Refer to the List Transient example for more information on how to program lists. You must program the voltage values and dwell times as explained in that example. You must also program a slew rate for each point in the list (even if it is 9.9+E37).

### Display

VOLT:M FIXED

SLEW 50

VOLT 120  
VOLT:T 150  
SLEW:M STEP

SLEW: 9.9+E37

SLEW:T 50

INIT:IMMED

VOLT 120  
VOLT:T 150  
SLEW:M PULSE

COUNT 2  
DCYCLE 33  
PER .0166

SLEW: 9.9+E37

SLEW:T 50

INIT:IMMED

---

**NOTE:** When specifying a dwell time, you must take the slew time into consideration. If the dwell time at any given list point is less than the slew time at the same point, the voltage will never reach its programmed level before the next list point becomes active.

---



## 9 - Measuring Peak Inrush Current

Peak inrush current is a non-repetitive measurement in the sense that peak inrush current occurs only when the unit under test is first turned on. In order to repeat the measurement, you must turn the unit off and wait for any input filter capacitors to discharge completely.

This example shows you how you can measure the peak inrush current using the front panel meter. The voltage is set to 120 V rms and the output is triggered at an output phase of 75°, which optimizes the conditions under which inrush current is applied to the unit under test.

Action	Display
1. Set the immediate voltage to 0. Press <b>Voltage</b> , then press <b>0</b> and <b>Enter</b> .	VOLT 0
2. Set the triggered voltage to 120 V rms. In the Voltage menu, press ▼ to access the triggered voltage command. Then press <b>1 2 0 Enter</b> .	VOLT:T 120
3. Set the voltage mode to step. In the Voltage menu, press ▼ to access the mode command. Press ⏴ to scroll to STEP and press <b>Enter</b> .	VOLT:M STEP
4. Make sure the triggered voltage slew rate is set to the fastest possible speed. In the Voltage menu, access the triggered slew command. If necessary, reset the slew rate to a faster speed.	SLEW:T 9.9000+E37
5. Make sure the peak current and rms current limits are set to high values. In the Current menu, access the rms current limit and then the peak current limit commands. If necessary, reset the rms current and the peak current limits to higher values. (Agilent 6811B units have an rms current limit of 3.25 A. Agilent 6813B units have an rms current limit of 13 A and a peak current limit of 80 A)	CURR:LEV 6.5 CURR:PEAK 40
6. Synchronize the trigger source with a reference phase angle. In the Trigger Control menu, press ▼ to access the sync source command. Press ⏴ to obtain PHASE and press <b>Enter</b> .	SYNC:SOUR PHASE
7. Set the reference phase angle to 75°. In the Trigger Control menu, press ▼ to access the sync phase command. Then press <b>7 5 Enter</b> .	SYNC:PHAS 75
8. Initiate (or enable) the unit for one immediate trigger from the front panel. Press <b>Trigger Control</b> and <b>Enter</b> .	INIT:IMMED
9. Set the meter function to measure nonrepetitive peak inrush current. In the Meter menu, press ▼ to access the peak inrush current display.	0 A PK NR
10. Enable the output by pressing Output On/Off.	0 V 60 HZ
11. Send the trigger to step the output from 0 V to 120 V. Press <b>Shift Trigger</b> . The inrush current is displayed on the Meter.	48 A PK NR

---

**NOTE:** With fast and/or large voltage transitions, the CC annunciator may turn on due to current in the output capacitor. This is normal and will limit the rate of change of output voltage. To prevent the CC operating mode from limiting the rate of change of output voltage, program the peak current limit to a higher value.

---

## 4 - Front Panel Operation

### 10 - Setting the GPIB Address and RS-232 Parameters

Your ac source is shipped with the GPIB address set to 5 This address can only be changed from the front panel using the Address menu located under the **Address** key. This menu is also used to select the RS-232 interface and specify RS-232 parameters such baud rate and parity.

Action	Display
<b>To set the GPIB address, proceed as follows:</b>	
1. On the System keypad, press <b>Address</b> .	ADDRESS 5
2. Enter the new address. For example, Press <b>7, Enter</b> .	ADDRESS 7
<b>To configure the RS-232 interface, proceed as follows:</b>	
1. On the System keypad, press <b>Address</b> .	ADDRESS 5
2. Scroll through the Address menu by pressing <b>▼</b> . The interface command lets you select the RS-232 interface. The baudrate command lets you select the baudrate. The parity command lets you select the parity.	INTF RS232 BAUDRATE 600 PARITY EVEN
3. The <b>▲</b> and <b>▼</b> keys let you select the command parameters.	

### 11 - Saving and Recalling Operating States

You can save up to 16 states (from location 0 to location 15) in non-volatile memory and recall them from the front panel. All programmable settings are saved. List data, however, cannot be saved in state storage. Only **one** list is saved in non-volatile memory.

Action	Display
<b>To save an operating state in location 1, proceed as follows:</b>	
1. Set the instrument to the operating state that you want to save.	
2. Save this state to location 1. Press <b>Shift Save 1 Enter</b> .	*SAV 1
<b>To recall a saved state in location 1, proceed as follows:</b>	
1. Recall the state saved in location 1 by pressing <b>Recall 1 Enter</b>	*RCL 1
<b>To select the power-on state of the ac source, proceed as follows:</b>	
1. On the Function keypad, press <b>Shift Output</b> , and scroll through the Output menu until you get to the PON state command.	PON:STATE RST
2. Use the <b>▲</b> and <b>▼</b> keys to select either RST or RCL0. RST sets the power-on state of the unit as defined by the *RST command. RCL0 sets the power-on state of the unit to the state saved in *RCL location 0.	
<b>To clear the non-volatile memory of the ac source, proceed as follows:</b>	
1. On the Function keypad, press <b>Shift Output</b> and scroll to the *RST command. Then press <b>Enter</b> . This returns the unit to the factory-default settings.	*RST
2. Save these settings to location 1. Press <b>Shift Save 1 Enter</b> .	*SAV 1
3. Repeat step #2 for memory locations 2 through 16..	*SAV 2 *SAV 3 *SAV 4 . . ...*SAV 16

## Specifications

### Specifications

Table A-1 lists the specifications of the ac source. Performance specifications are warranted over the ambient temperature range of 0 to 40 °C. Unless otherwise noted, specifications are for a sinewave with a resistive load at an output frequency range of 45 Hz to 1 kHz, in ac-coupled mode after a 30-minute warmup. Refer to table A-3 for ac source operation with output frequencies from dc to 45 Hz.

**Table A-1. Performance Specifications<sup>1</sup>**

Parameter		Agilent 6811B	Agilent 6812B	Agilent 6813B
<b>Phases:</b>		1	1	1
<b>Maximum Output Ratings</b>				
	<b>Power (VA):</b>	375 VA	750 VA	1750 VA
	<b>dc Power (Watts):</b>	285 W	575 W	1350 W
	<b>rms Voltage:</b>	300 V	300 V	300 V
	<b>dc Voltage:</b>	± 425 V	± 425 V	± 425 V
	<b>rms Current (in real-time mode):</b>	3.25 A	6.5 A	13 A
	<b>dc Current:</b>	2.5 A	5 A	10 A
	<b>Repetitive peak Current<sup>2</sup>:</b>	40 A	40 A	80 A
	<b>Non-repetitive peak Current<sup>2</sup></b>	40 A	40 A	80 A
	(inrush):			
	<b>Crest Factor<sup>2</sup> (current):</b>	12	6	6
<b>Output Frequency Range<sup>3</sup>:</b>		dc; 45 Hz–1 kHz		
<b>Constant Voltage Ripple and Noise (20 kHz–10 MHz):</b>	<b>rms relative to full scale:</b>	–60 dB		
	<b>rms:</b>	300 mV		
<b>Regulation:</b>	<b>Load (rms detection mode):</b>	0.5% of full scale		
	<b>Line:</b>	0.1% of full scale		
<b>Maximum Total Harmonic Distortion:</b>		0.25% at 50 Hz/60 Hz 1% worst-case 45 Hz–1 kHz		
<b>Load Power Factor Capability:</b>		0–1		
<b>Maximum Fixed dc Offset Voltage (ac coupled):</b>		100 mV		
<b>Programming Accuracy (rms detection mode @ 25°C ±5°C), ±(% of output+offset)</b>	<b>rms Voltage</b> (45–100 Hz):	0.15% + 0.3 V		
	(>100–500 Hz):	0.5% + 0.3 V		
	(>500 Hz–1 kHz):	1% + 0.3 V		
	<b>Frequency:</b>	0.01% + 10 µHz		
	<b>dc Voltage:</b>	0.1% + 0.5 V	0.1% + 0.5 V	0.5% + 0.3 V
<b>Measurement Accuracy (@25°C ±5°C), ±(% of output + offset)</b>	<b>rms Voltage</b> (45–100 Hz):	0.03% + 100 mV		
	(>100–500 Hz):	0.1% + 100 mV		
	(>500 Hz–1 kHz):	0.2% + 100 mV		
	<b>Frequency:</b>	0.01% + 0.01 Hz		
	<b>dc Voltage:</b>	0.05% + 150 mV		

A - Specifications

**Table A-1. Performance Specifications (continued)**

Parameter	Agilent 6811B/6812B/6813B	
<b>Measurement Accuracy</b> (continued)	<b>rms Current High Range</b> (45–100 Hz): (>100–500 Hz): (>500 Hz–1 kHz): <b>rms Current Low Range</b> (45–100 Hz): (>100–500 Hz): (>500 Hz–1 kHz): <b>repetitive pk current High Range</b> (45 Hz–1 kHz): <b>repetitive pk current Low Range</b> (45 Hz–1 kHz): <b>Power (VA) Low Range</b> (45–100 Hz): (>100–500 Hz): (>500 Hz–1 kHz): <b>Power (VA) High Range</b> (45–100 Hz): (>100–500 Hz): (>500 Hz–1 kHz): <b>Power (Watts) Low Range</b> (45–100 Hz): (>100–500 Hz): (>500 Hz–1 kHz): <b>Power (Watts) High Range</b> (45–100 Hz): (>100–500 Hz): (>500 Hz–1 kHz): <b>Power Factor:</b>	0.05% + 10 mA 0.05% + 15 mA 0.05% + 30 mA 0.05% + 1.5 mA 0.05% + 8 mA 0.05% + 25 mA 0.05% + 150 mA 0.03% + 150 mA 0.1% + 1.5 VA + 1.2 mVA/V 0.1% + 2 VA + 1.2 mVA/V 0.1% + 6 VA + 1.2 mVA/V 0.1% + 1.5 VA + 12 mVA/V 0.1% + 2 VA + 12 mVA/V 0.1% + 6 VA + 12 mVA/V 0.1% + 0.3 W + 1.2 mW/V 0.1% + 1.2 W + 1.2 mW/V 0.1% + 2.5 W + 1.2 mW/V 0.1% + 0.3 W + 12 mW/V 0.1% + 1.2 W + 12 mW/V 0.1% + 2.5 W + 12 mW/V 0.01
<b>Harmonic Measurement Accuracy</b> (50/60 Hz, @25°C ±5°C), ± (% of output + offset)	<b>Voltage Magnitude:</b>  <b>Current Magnitude (Low Range)</b> <b>Fundamental:</b> <b>Harmonics 2–49:</b> <b>Current Magnitude (High Range)</b> <b>Fundamental:</b> <b>Harmonics 2–49:</b>	0.03% + 100 mV + 0.2%/kHz  0.03% + 1.5 mA 0.03% + 1 mA + 0.2%/kHz  0.05% + 5 mA 0.03% + 3 mA + 0.2%/kHz

<sup>1</sup>Specifications subject to change without notice.

<sup>2</sup>These specifications are subject to the restrictions of Table 1-3.

<sup>3</sup>Product may be operated between dc and 45 Hz subject to operating conditions described in Table A-3.

## Supplemental Characteristics

Table A-2 lists the supplemental characteristics, which are not warranted but are descriptions of typical performance determined either by design or type testing.

**Table A-2. Supplemental Characteristics**

Parameter	Agilent 6811B	Agilent 6812B	Agilent 6813B
<b>ac Input Voltage Range (Vac):</b>	87–106 Vac (100 Vac nom.) 104–127 Vac (120 Vac nom.) 174–220 Vac (200/208 Vac nom.) 191–254 Vac (230 Vac nom.)		174–220 Vac (200/208 Vac nom.) 191–254 Vac (230 Vac nom.)
<b>Maximum Input Current (rms):</b>	12 A (100 Vac), 10 A (120 Vac), 7.5 A (200/208 Vac), 6.5 A (230 Vac)	28 A (100 Vac), 24 A (120 Vac), 15 A (200/208 Vac), 13A (230 Vac)	20 A (230 Vac) 22 A (200/208 Vac)
<b>Maximum Input Power:</b>	1000 VA/700 W	2500 VA/1400 W	3800 VA/2600 W
<b>ac Input Frequency:</b>	47–63 Hz		
<b>Isolation to Ground:</b>	300 Vrms/425 Vdc		
<b>Output Voltage Risettime:</b> (output change from 10 to 90% or 90 to 10% of its total excursion with full resistive load)	50 $\mu$ s		
<b>Remote Inhibit Response Time:</b>	15 ms		
<b>Remote Sense Capability:</b>	Up to 1 Vrms can be dropped across each load lead.		
<b>Programmable Output Impedance Ranges</b>			
<b>Resistance:</b>	0–1 $\Omega$		
<b>Inductance:</b>	20 $\mu$ H–1 mH		
<b>Average Programming Accuracy</b>			
<b>rms Current:</b>	1.2% of output + 50 mA		
<b>OVP:</b>	2% of output + 5 Vpeak		
<b>ac Voltage Slew Rate (rms):</b>	0.1 V/s		
<b>Frequency Slew Rate:</b>	$\pm$ 0.01%		
<b>Average Programming Resolution</b>			
<b>rms Voltage:</b>	125 mV		
<b>dc Voltage:</b>	250 mV		
<b>ac Voltage Slew Rate (rms):</b>	6 mV/s		
<b>dc Voltage Slew Rate:</b>	20 mV/s		
<b>Frequency Slew Rate:</b>	0.05 Hz/s		
<b>Overvoltage Programming (OVP):</b>	2 Vpeak		
<b>rms Current:</b>	2 mA	4 mA	4 mA
<b>peak Current:</b>	12.5 mA	25 mA	25 mA
<b>Output Frequency:</b>	10 $\mu$ Hz		
<b>Output Impedance</b>			
<b>Resistive Component:</b>	0.01 $\Omega$		
<b>Inductive Component:</b>	10 $\mu$ H		
<b>Average Measurement Resolution</b>			
<b>rms Voltage:</b>	10 mV		
<b>rms Current:</b>	2 mA		
<b>THD (for a fundamental amplitude <math>\geq</math> 5% of full scale):</b>	5% of reading + 0.1%		
<b>Measurement System</b>			
<b>Measurement Buffer Length:</b>	4096 points		
<b>Measurement/Generation Synchronization:</b>	$\leq$ 50 $\mu$ s		
<b>Measurement Acquisition Sampling Rate Range:</b>	25–250 $\mu$ s		
<b>Voltage/Current Digitization Accuracy:</b>	12 bits		
<b>Voltage/Current Digitization Resolution:</b>	16 bits		
<b>Harmonic Measurement Time (amplitude):</b>			
<b>Meas:Curr:Harm? &lt;n&gt;</b>	400 ms		
<b>Meas:Array:Curr:Harm?</b>	10 s		

A - Specifications

**Table A-2. Supplemental Characteristics (continued)**

Parameter	Agilent 6811B	Agilent 6812B	Agilent 6813B
<b>Transient System</b>			
<b>Phase Synchronization:</b>		± 100 µs	
<b>Pulse Width Range:</b>		200 µs to 4.3 x 10 <sup>5</sup> seconds	
<b>Pulse/Dwell Timing Accuracy:</b>		± 0.01%	
<b>Pulse Duty Cycle Range:</b>		0 to 100 %	
<b>Pulse Count Range:</b>		1 to Infinity Pulses	
<b>LIST Length:</b>		1 to 100 steps	
<b>Minimum LIST Dwell Time:</b>		200 µs	
<b>LIST Count Range:</b>		1 to Infinity LIST repeats	
<b>External Trigger Response Time:</b>		200 µs	
<b>Maximum External Trigger Rate:</b>		1 kHz	
<b>Waveform Table Voltage Resolution:</b>		1024 points	
<b>RS-232 Interface Capabilities</b>			
<b>Baud Rates:</b>		300, 600, 1200, 2400, 4800, 9600	
<b>Data Format:</b>		7 bits even or odd parity; 8 bits without parity	
<b>Language:</b>		SCPI (Standard Commands for Programmable Instruments), Elgar 9012 PIP	
<b>Trig In/Trig Out Characteristics</b>			
<b>Trig Out (HC TTL output):</b>		$V_{oh} = 0.8 \text{ V max. @ } 1.25 \text{ mA}$ $V_{oh} = 3.3 \text{ V max. @ } 1.25 \text{ mA}$	
<b>Trig In (10k pullup):</b>		$V_{il} = 0.8 \text{ V max.}$ $V_{ih} = 2 \text{ V max.}$	
<b>INH/FLT Characteristics</b>			
<b>Maximum Ratings:</b>		16.5 Vdc between INH terminals; FLT terminals; and from INH terminals to chassis ground	
<b>INH Terminals:</b>		$I_{ol} = 1.25 \text{ mA max.}$ $V_{ol} = 0.5 \text{ V max.}$ $V_{il} = 0.8 \text{ V max.}$ $V_{ih} = 2 \text{ V min.}$ $tw = 100 \text{ µs min.}$ $td = 4 \text{ ms typical}$	
<b>FLT Terminals:</b>			
<b>Saveable Data (nonvolatile)</b>			
<b>Instrument States:</b>		16 (0 to 15)	
<b>User-defined waveforms</b>		12 (with 1024 data points in each)	
<b>List data:</b>		1 to 100 steps (for each list function)	
<b>GPIB Interface Capabilities</b>			
<b>Language:</b>		SCPI, Elgar 9012 PIP	
<b>Interface:</b>		AH1, C0, DC1, DT1, E2, LE1, PP0, RL1, SH1, SR1, TE6	
<b>Programming Time:</b>		10 ms	
<b>Recommended Calibration Interval:</b>		1 year	
<b>Regulatory Compliance</b>			
<b>Listed to:</b>		UL 3111-1	
<b>Certified to:</b>		CSA 22.2 No. 1010-1	
<b>Conforms to:</b>		IEC 1010	
<b>RFI Suppression Complies with:</b>		CISPR-11, Group 1, Class A	
<b>Dimensions</b>			
<b>Height (add 12.7 mm or 0.5 in. for feet)</b>		132.6 mm (5.25 in.)	
<b>Width:</b>		425.5 mm (16.75 in.)	
<b>Depth:</b>		574.7 mm (22.6 in.)	
<b>Net Weight:</b>	28.2 kg (62 lb)		32.7 kg (72 lb)
<b>Shipping Weight:</b>	31.8 kg (70 lb)		36.4 kg (80 lb)

## Operation Below 45 Hz

The following operating characteristics apply for output frequencies between 45Hz and 1Hz. Below 1 Hz, instantaneous values meet the dc specifications. The ac source output is set to: sinewave, dc coupled, real-time regulation, and is connected to a linear load.

**Table A-3. Operation Below 45 Hz**

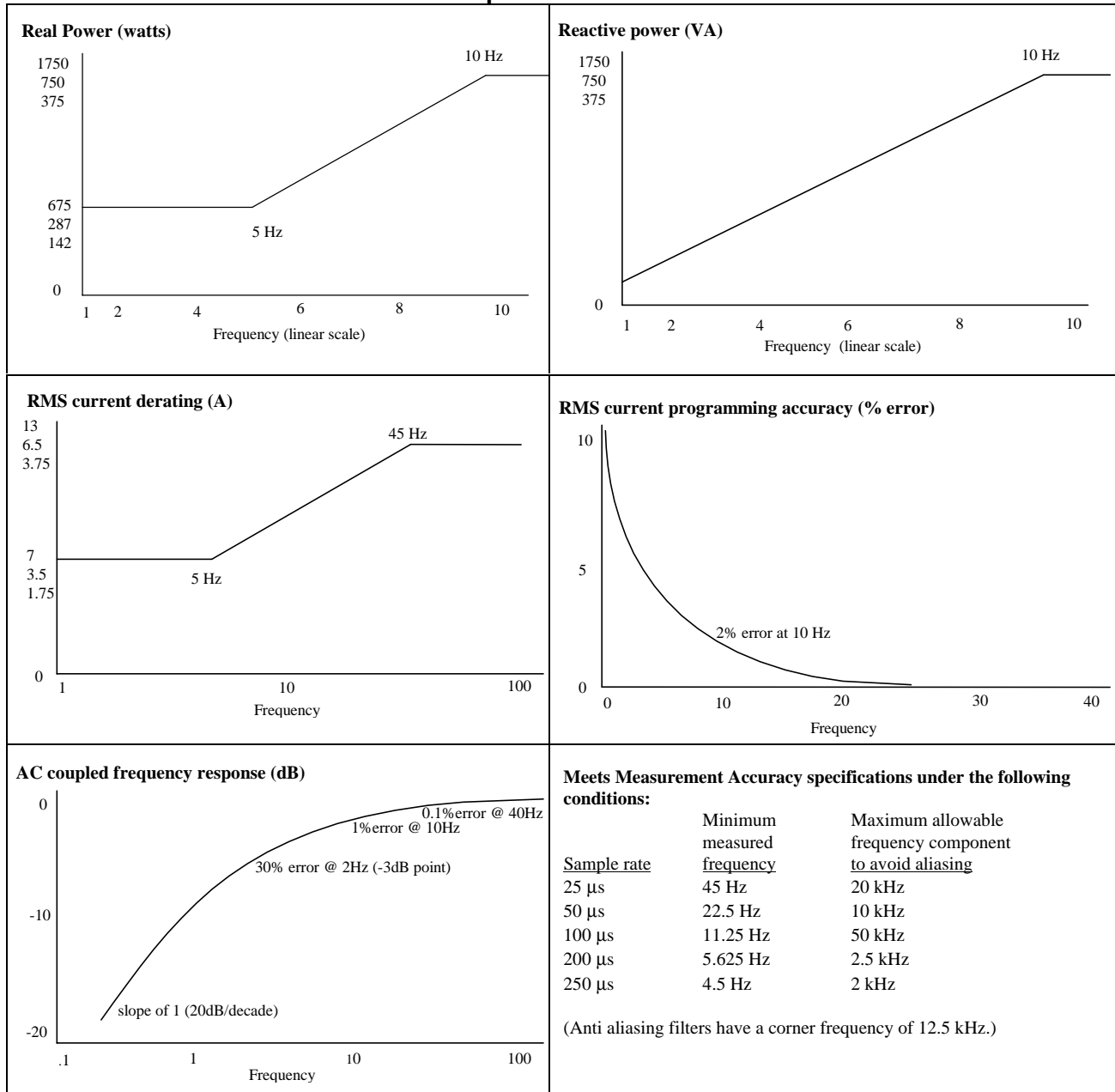





## Verification and Calibration

---

### Introduction

This appendix includes verification and calibration procedures for the Agilent 6811B/6812B/6813B AC Power Solutions. Instructions are given for performing the procedures either from the front panel or from a controller over the GPIB.

The verification procedures do not check all the operating parameters, but verify that the ac source is performing properly. Performance Tests, which check all the specifications of the ac source, are given in the applicable ac source Service Manual.

Because the output of the ac source must be enabled during verification or calibration, proceed with caution, since voltages and currents will be active at the output terminals.

---

**Important** Perform the verification procedures before calibrating your ac source. If the ac source passes the verification procedures, the unit is operating within its calibration limits and does not need to be recalibrated.

---

---

**WARNING:** *LETHAL VOLTAGES.* Ac sources can supply 424 V peak at their output. DEATH on contact may result if the output terminals or circuits connected to the output are touched when power is applied. These procedures must be performed by a qualified electronics technician or engineer trained on this equipment.

---

### Equipment Required

The equipment listed in the following table, or the equivalent to this equipment, is required for verification and calibration.

## B - Verification and Calibration

**Table B-1. Equipment Required**

Equipment	Characteristics	Recommended Model
Digital Voltmeter	Resolution: 10 nV @ 1 V Readout: 8.5 digits Accuracy: >20 ppm	Agilent 3458A
Current Monitor <sup>1</sup>	0.01 $\Omega$ , $\pm$ 200 ppm, 10 Watts	Guidline 7320/0.01
Ratio Transformer <sup>2</sup>	30:1 ratio, 50 ppm, 45 Hz to 1 kHz	
Load Resistor	20 $\Omega$ , 10 A, 1800 Watts min.	
Impedance Resistor	1 $\Omega$ , 100 Watts min.	
GPIB Controller	Full GPIB capabilities	HP Series 200/300 or equivalent

<sup>1</sup>The 4-terminal current shunt is used to eliminate output current measurement error caused by voltage drops in the load leads and connections. It has special current-monitoring terminals inside the load connection terminals. Connect the voltmeter directly to these current-monitoring terminals.

<sup>2</sup>A ratio transformer is required only when verifying output voltage readback to MIL-STD-45662A 4:1 test equipment ratio requirements.

### Test Setup

Figure B-1 shows the setup for the tests. Be certain to use load leads of sufficient wire gauge to carry the full output current (see Chapter 2).

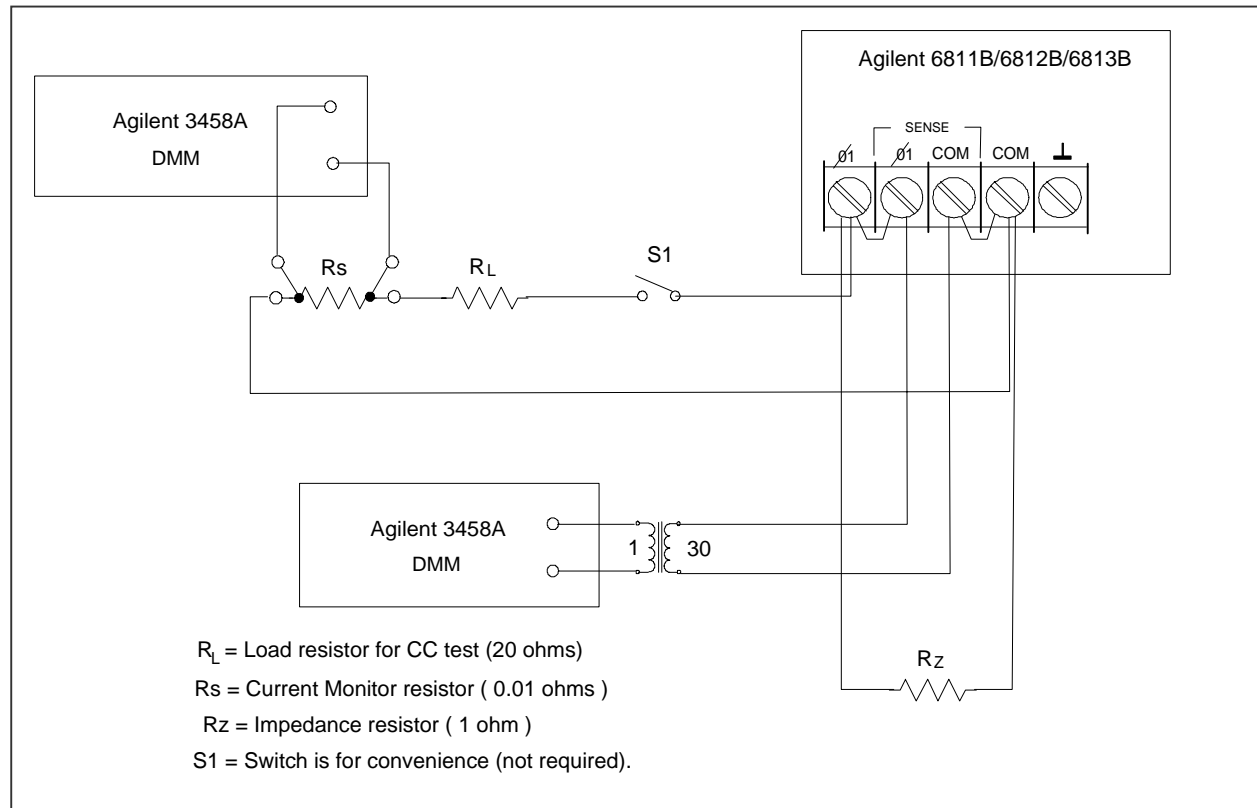

**Figure B-1. Verification & Calibration Test Setup**

---

## Performing the Verification Tests

The following procedures assume you understand how to operate the ac source from the front panel as explained in Chapter 4.

When performing the verification tests from a GPIB controller, you may have to consider the relatively slow settling times and slew rates of the ac source as compared to computer and system voltmeters. Suitable WAIT statements can be inserted into the test program to give the ac source time to respond to the test commands.

Perform the following tests for operation verification in the order indicated.

1. Turn-On Checkout
2. Voltage Programming and Measurement Accuracy
3. Current Measurement Accuracy

### Turn-On Checkout Procedure

Perform the Turn-On Checkout as directed in Chapter 3.

---

**NOTE:** The ac source must pass turn-on selftest before you can proceed with the verification tests.

---

### AC Voltage Programming and Measurement Accuracy

This test verifies the voltage programming, GPIB measurement, and front panel meter functions. Values read back over the GPIB should be the same as those displayed on the front panel.

If more than one meter or if a meter and an oscilloscope are used, connect each to the sense terminals by separate leads to avoid mutual coupling effects.

<b>Action</b>	<b>Normal Result</b>
1. Make sure the ac source is turned off. Connect the DVM and ratio transformer as shown in the test setup in Figure B-1.	
2. Turn on the ac source with no load. In the Output menu, execute the *RST command to reset the unit. Enable the output by pressing <b>Output On/Off</b> . Program the output voltage as follows:  VOLT 300, FREQ 45, SHAPE:SIN, CURR 1	<b>CV</b> annunciator on. Output current near 0.
3. Record voltage readings at the DVM <sup>1</sup> and on the front panel display.	Readings within specified High range limits (300 V/45 Hz).
4. Program FREQ 400	
5. Record voltage readings at the DVM <sup>1</sup> and on the front panel display.	Readings within specified High range limits (300 V/400 Hz).
4. Program FREQ 1000, CURR:PEAK 40	
7. Record voltage readings at the DVM <sup>1</sup> and on the front panel display.	Readings within specified High range limits (300 V/1 kHz).

<sup>1</sup>Multiply the DVM reading by the transformer ratio if a ratio transformer is used.

## DC Voltage Programming and Measurement Accuracy

**CAUTION:** Disconnect the ratio transformer for this test.

This test verifies the dc voltage programming, GPIB readback, and front panel meter functions. Values read back over the GPIB should be the same as those displayed on the front panel. Connect the negative terminal of the DVM to the COM output terminal to determine the  $\pm$  dc offset voltages.

<b>Action</b>	<b>Normal Result</b>
1. Make sure the ac source is turned off. Connect the DVM directly to the sense terminals.	
2. Turn on the ac source with no load. In the Output menu, execute the *RST command to reset the unit. Enable the output by pressing <b>Output On/Off</b> . Program the output voltage as follows:  VOLT 0, OUTP:COUP DC, OFFSET 425	Output voltage at +425 Vdc Output current near 0.
3. Record DC voltage readings at the DVM and on the front panel display.	Readings within specified dc voltage programming and readback limits.
4. Program OFFSET -425	Output voltage at -425 Vdc
5. Record DC voltage readings at the DVM and on the front panel display.	Readings within specified dc voltage programming and readback limits.

## RMS Current Accuracy Test

This test verifies the accuracy of the current measurement in rms detection mode.

<b>Action</b>	<b>Normal Result</b>
1. Turn off the ac source and connect the DVM, the 20 ohm load resistor and current shunt as shown in Figure B-1 with S1 closed. Connect the DVM across the current shunt.	
2. Turn on the ac source. In the Output menu, execute the *RST command to reset the unit. Enable the output by pressing <b>Output On/Off</b> . Program the output as follows:  For Agilent 6811B: VOLT 60, CURR:RANGE LOW, CURR:LEV 2.50  For all other models: VOLT 120, CURR:RANGE LOW, CURR:LEV 5.00	CC annunciator on Output current at 2.5 (Agilent 6811B) or 5.0 A (all other models).
3. Record the DVM voltage reading and calculate the rms current.	Readings within specified limits.
4. Program CURR:RANGE HIGH	CC annunciator on Output current at 2.5 (Agilent 6811B) or 5.0 A (all other models).
5. Record the DVM voltage reading and calculate the rms current.	Readings within specified limits.

**Table B-2. Agilent 6811B Verification Test Record**

Model Agilent 6811B		Report No. _____	Date _____
Test Description	Minimum Specification	Recorded Results	Maximum Specification
<b>Voltage Programming and Measurement Accuracy</b>			
300 Vrms accuracy at 45 Hz Front Panel Measurement	299.250 V Vrms -190 mV	_____V _____V	300.750 V Vrms +190 mV
300 Vrms accuracy at 400 Hz Front Panel Measurement	298.200 V Vrms -400 mV	_____V _____V	301.800 V Vrms +400 mV
300 Vrms accuracy at 1 kHz Front Panel Measurement	296.700 V Vrms -700 mV	_____V _____V	303.300 V Vrms +700 mV
<b>DC Programming and Measurement Accuracy</b>			
425 Vdc accuracy Front Panel Measurement	424.075 V Vdc -0.363 V	_____V _____V	425.925 V Vrms +0.363 V
-425 Vdc accuracy Front Panel Measurement	-424.075 V Vdc -0.363 V	_____V _____V	-425.925 V Vrms +0.363 V
<b>RMS Current Measurement Accuracy</b>			
Low Range High Range (Iout = calculated output current @ 60Hz)	Iout -0.00275 A Iout -0.01125 A	_____A _____A	Iout +0.00275 A Iout +0.01125 A

**Table B-3. Agilent 6812B Verification Test Record**

Model Agilent _____		Report No. _____	Date _____
Test Description	Minimum Specification	Recorded Results	Maximum Specification
<b>Voltage Programming and Measurement Accuracy</b>			
300 Vrms accuracy at 45 Hz Front Panel Measurement	299.250 V Vrms -190 mV	_____V _____V	300.750 V Vrms +190 mV
300 Vrms accuracy at 400 Hz Front Panel Measurement	298.200 V Vrms -400 mV	_____V _____V	301.800 V Vrms +400 mV
300 Vrms accuracy at 1 kHz Front Panel Measurement	296.700 V Vrms -700 mV	_____V _____V	303.300 V Vrms +700 mV

B - Verification and Calibration

**Table B-3 (continued)**

<b>DC Programming and Measurement Accuracy</b>			
425 Vdc accuracy Front Panel Measurement	424.075 V Vdc -0.363 V	_____V _____V	425.925 V Vrms +0.363 V
-425 Vdc accuracy Front Panel Measurement	-424.075 V Vdc -0.363 V	_____V _____V	-425.925 V Vrms +0.363 V
<b>RMS Current Measurement Accuracy</b>			
Low Range High Range (Iout = calculated output current @ 60Hz)	Iout -0.0040 A Iout -0.0125 A	_____A _____A	Iout +0.0040 A Iout +0.0125 A

**Table B-4. Agilent 6813B Verification Test Record**

Model Agilent _____	Report No. _____	Date _____	
Test Description	Minimum Specification	Recorded Results	Maximum Specification
<b>Voltage Programming and Measurement Accuracy</b>			
300 Vrms accuracy at 45 Hz Front Panel Measurement	299.250 V Vrms -190 mV	_____V _____V	300.750 V Vrms +190 mV
300 Vrms accuracy at 400 Hz Front Panel Measurement	298.200 V Vrms -400 mV	_____V _____V	301.800 V Vrms +400 mV
300 Vrms accuracy at 1 kHz Front Panel Measurement	296.700 V Vrms -700 mV	_____V _____V	303.300 V Vrms +700 mV
<b>DC Programming and Measurement Accuracy</b>			
425 Vdc accuracy Front Panel Measurement	422.575 V Vdc -0.363 V	_____V _____V	427.425 V Vrms +0.363 V
-425 Vdc accuracy Front Panel Measurement	-422.575 V Vdc -0.363 V	_____V _____V	-427.425 V Vrms +0.363 V
<b>RMS Current Measurement Accuracy</b>			
Low Range High Range (Iout = calculated output current @ 60Hz)	Iout -0.0040 A Iout -0.0125 A	_____A _____A	Iout +0.0040 A Iout +0.0125 A

## Performing the Calibration Procedure

Table B-1 lists the equipment required for calibration. Figure B-1 shows the test setup.

**NOTE:** You do not have to do a complete calibration each time. You may calibrate only the voltage or current and proceed to "Saving the Calibration Constants." However, before you calibrate OVP, you must first calibrate the output voltage.

The following parameters may be calibrated:

- ◆ ac output voltage
- ◆ output voltage measurement
- ◆ overvoltage protection (OVP)
- ◆ ac output current
- ◆ output current measurement
- ◆ output impedance

Before calibrating the output impedance, you must first calibrate the output voltage and the output current.

### Front Panel Calibration Menu

The Entry keypad is used for calibration functions.

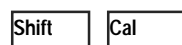

Press this key to access the calibration menu.

#### Display

CAL ON <value>

CAL OFF

CAL:LEV <char>

CAL:DATA <value>

CAL:VOLT:OFFSET

CAL:VOLT:DC

CAL:VOLT:AC

CAL:VOLT:PROT

CAL:CURR:AC

CAL:CURR:MEAS

CAL:IMP

CAL:SAVE

CAL:PASS <value>

#### Command Function

Turns calibration mode on when the correct password value is entered.

Turns calibration mode off

Advance to next step in sequence (P1, P2, P3, or P4).

Input a calibration measurement.

Begin voltage offset calibration

Begin dc voltage calibration sequence

Begin ac voltage calibration sequence

Begin voltage protection calibration

Begin ac current calibration sequence

Begin current measurement calibration sequence

Begin output impedance calibration sequence



Saves the calibration constants in non-volatile memory.



Set new calibration password.

#### Notes:

value = a numeric value

char = a character string parameter

Use  and  to scroll through the command list.

Use  and  to scroll through the parameter list.

---

## Front Panel Calibration

---

**WARNING:** *LETHAL VOLTAGES.* Ac sources can supply 424 V peak at their output. DEATH on contact may result if the output terminals or circuits connected to the output are touched when power is applied. These procedures must be performed by a qualified electronics technician or engineer trained on this equipment.

---

The following procedures assume you understand how to operate front panel keys (see Chapter 4).

### Enable Calibration Mode

Action	Display
1. Reset the unit by selecting <b>Output</b> , scrolling to the *RST command and pressing <b>Enter</b> .	*RST
2. To begin calibration press <b>Shift Cal</b> , scroll to CAL ON and press <b>Enter</b> .	CAL ON 0.0
3. Enter the calibration password from Entry keypad and press <b>Enter</b> . If the password is correct the <b>Cal</b> annunciator will come on.	
If CAL DENIED appears, then an internal switch has been set to prevent the calibration from being changed. (see the Service Manual.)	CAL DENIED
If the password is incorrect, an error occurs. If the active password is lost, the calibration function can be recovered by setting an internal switch that defeats password protection. (see the Service Manual.)	OUT OF RANGE

### Calibrating and Entering Voltage Offset Values

Connect the negative terminal of the DVM to the COM output terminal. Note that some calibration points are negative; be sure to enter the CAL:DATA as negative values when required.

Action	Display
4. Connect the DVM (dc volts mode) directly to the ac source. Do not connect the ratio transformer or load resistor shown in Figure B-1.	
5. Press <b>Shift Calibration</b> , scroll to the CAL VOLT OFFSET command, and press <b>Enter</b> .	CAL:VOLT:OFFSET
6. Press <b>Shift Calibration</b> , scroll to the CAL LEV P1 command, and press <b>Enter</b> to select the first calibration point.	CAL:LEV P1
7. Press <b>Shift Calibration</b> , scroll to CAL DATA 0.00, and use the Entry keypad to enter the dc voltage value displayed on the DVM.	CAL:DATA 0.00
8. Press <b>Shift Calibration</b> , scroll to the CAL LEV P1 command, use ↓ to scroll to the P2 parameter, and press <b>Enter</b> . This selects the second calibration point.	CAL:LEV P2
9. Press <b>Shift Calibration</b> , scroll to CAL DATA 0.00, and use the Entry keypad to enter the dc voltage value displayed on the DVM.	CAL:DATA 0.00
10. Press <b>Shift Calibration</b> , scroll to the CAL LEV P1 command, use ↓ to scroll to the P3 parameter, and press <b>Enter</b> .	CAL:LEV P3



- |     |   |               |
|-----|---|---------------|
| 11. | Press <b>Shift Calibration</b> , scroll to CAL DATA 0.00, and use the Entry keypad to enter the dc voltage value displayed on the DVM.  | CAL:DATA 0.00 |
| 12. | Press <b>Shift Calibration</b> , scroll to the CAL LEV P1 command, use <b>↓</b> to scroll to the P4 parameter, and press <b>Enter</b> . | CAL:LEV P4    |
| 13. | Press <b>Shift Calibration</b> , scroll to CAL DATA 0.00, and use the Entry keypad to enter the dc voltage value displayed on the DVM.  | CAL:DATA 0.00 |

The ac source is now holding the new voltage offset calibration constants in RAM.

## Calibrating and Entering DC Voltage Gain Values

Connect the negative terminal of the DVM to the COM output terminal. Note that some calibration points are negative; be sure to enter the CAL:DATA as negative values when required.

- | Action   | Display       |
|--|---------------|
| 14. Connect the DVM (dc volts mode) directly to the ac source. Do not connect the ratio transformer or load resistor shown in Figure B-1.  |               |
| 15. Press <b>Shift Calibration</b> , scroll to the CAL VOLT DC command, and press <b>Enter</b> .   | CAL:VOLT:DC   |
| 16. Press <b>Shift Calibration</b> , scroll to the CAL LEV P1 command, and press <b>Enter</b> to select the first calibration point.   | CAL:LEV P1    |
| 17. Press <b>Shift Calibration</b> , scroll to CAL DATA 0.00, and use the Entry keypad to enter the dc voltage value displayed on the DVM.   | CAL:DATA 0.00 |
| 18. Press <b>Shift Calibration</b> , scroll to the CAL LEV P1 command, use <b>↓</b> to scroll to the P2 parameter, and press <b>Enter</b> . This selects the second calibration point. | CAL:LEV P2    |
| 19. Press <b>Shift Calibration</b> , scroll to CAL DATA 0.00, and use the Entry keypad to enter the dc voltage value displayed on the DVM.   | CAL:DATA 0.00 |
| 20. Press <b>Shift Calibration</b> , scroll to the CAL LEV P1 command, use <b>↓</b> to scroll to the P3 parameter, and press <b>Enter</b> .  | CAL:LEV P3    |
| 21. Press <b>Shift Calibration</b> , scroll to CAL DATA 0.00, and use the Entry keypad to enter the dc voltage value displayed on the DVM.   | CAL:DATA 0.00 |

The ac source is now holding the new dc voltage gain calibration constants in RAM.

## Calibrating and Entering AC rms Voltage Gain Values

- | Action  | Display       |
|---|---------------|
| 22. Connect the DVM (ac volts mode) to the ac source using the ratio transformer shown in Figure B-1.   |               |
| 23. Press <b>Shift Calibration</b> , scroll to the CAL VOLT AC command, and press <b>Enter</b> .  | CAL:VOLT:AC   |
| 24. Press <b>Shift Calibration</b> , scroll to the CAL LEV P1 command, and press <b>Enter</b> to select the first calibration point.  | CAL:LEV P1    |
| 25. Press <b>Shift Calibration</b> , scroll to CAL DATA 0.00, and use the Entry keypad to enter the product of the transformer ratio times the ac voltage value displayed on the DVM. | CAL:DATA 0.00 |

## B - Verification and Calibration

- |     |  |               |
|-----|--|---------------|
| 26. | Press <b>Shift Calibration</b> , scroll to the CAL LEV P1 command, use <b>↓</b> to scroll to the P2 parameter, and press <b>Enter</b> . This selects the second calibration point. | CAL:LEV P2    |
| 27. | Press <b>Shift Calibration</b> , scroll to CAL DATA 0.00, and use the Entry keypad to enter the product of the transformer ratio times the ac voltage value displayed on the DVM.  | CAL:DATA 0.00 |
| 28. | Press <b>Shift Calibration</b> , scroll to the CAL LEV P1 command, use <b>↓</b> to scroll to the P3 parameter, and press <b>Enter</b> .  | CAL:LEV P3    |
| 29. | Press <b>Shift Calibration</b> , scroll to CAL DATA 0.00, and use the Entry keypad to enter the product of the transformer ratio times the ac voltage value displayed on the DVM.  | CAL:DATA 0.00 |
| 30. | Press <b>Shift Calibration</b> , scroll to the CAL LEV P1 command, use <b>↓</b> to scroll to the P4 parameter, and press <b>Enter</b> .  | CAL:LEV P4    |
| 31. | Press <b>Shift Calibration</b> , scroll to CAL DATA 0.00, and use the Entry keypad to enter the product of the transformer ratio times the ac voltage value displayed on the DVM.  | CAL:DATA 0.00 |

The ac source is now holding the new ac rms voltage calibration constants in RAM.

## Calibrating the OVP Trip Point

- | Action  | Display       |
|---|---------------|
| 32. Press <b>Shift Calibration</b> , scroll to CAL VOLT PROT, and press <b>Enter</b> .  | CAL:VOLT:PROT |
| 33. Wait for the ac source to compute the OVP calibration constant. The display returns to Meter mode when the OVP calculation is complete. |               |

The ac source is now holding the new OVP calibration constants in RAM.

## Calibrating and Entering rms Current Values

- | Action  | Display       |
|---|---------------|
| 34. Connect the DVM (ac rms mode), current shunt, and load resistor as shown in figure B-1 with S1 closed.  |               |
| 35. Press <b>Shift Calibration</b> , scroll to the CAL CURR AC command, and press <b>Enter</b> .  | CAL:CURR:AC   |
| 36. Press <b>Shift Calibration</b> , scroll to the CAL LEV P1 command, and press <b>Enter</b> .   | CAL:LEV P1    |
| 37. Press <b>Shift Calibration</b> , scroll to the CAL DATA 0.00 command. Calculate the rms current value (DVM ac rms voltage/shunt resistance), and use the Entry keypad to enter the rms current. | CAL:DATA 0.00 |
| 38. Press <b>Shift Calibration</b> , scroll to the CAL LEV P1 command, use <b>↓</b> to scroll to the P2 parameter, and press <b>Enter</b> .   | CAL:LEV P2    |
| 39. Press <b>Shift Calibration</b> , scroll to the CAL DATA 0.00 command. Calculate the rms current value (DVM ac rms voltage/shunt resistance), and use the Entry keypad to enter the rms current. | CAL:DATA 0.00 |

The ac source is now holding the new rms current calibration constants in RAM.

## Calibrating and Entering rms Current Measurement Values

Action	Display
40. Connect the DVM (ac rms mode), current shunt, and load resistor as shown in figure B-1 with S1 closed.	
41. Press <b>Shift Calibration</b> , scroll to the CAL CURR MEAS command, and press <b>Enter</b> .	CAL:CURR:MEAS
42. Press <b>Shift Calibration</b> , scroll to the CAL LEV P1 command, and press <b>Enter</b> .	CAL:LEV P1
43. Press <b>Shift Calibration</b> , scroll to the CAL DATA 0.00 command. Calculate the rms current value (DVM ac rms voltage/shunt resistance), and use the Entry keypad to enter the rms current.	CAL:DATA 0.00
44. Press <b>Shift Calibration</b> , scroll to CAL LEV P1 command, use <b>↓</b> to scroll to the P2 parameter, and press <b>Enter</b> .	CAL:LEV P2
45. Press <b>Shift Calibration</b> , scroll to the CAL DATA 0.00 command. Calculate the rms current value (DVM ac rms voltage/shunt resistance), and use the Entry keypad to enter the rms current.	CAL:DATA 0.00

The ac source is now holding the new rms current measurement calibration constants in RAM.

## Calibrating the Output Impedance

Action	Display
46. Connect only the output impedance resistor across the output of the ac source. Do not connect any other equipment.	
47. Press <b>Shift Calibration</b> , scroll to the CAL IMP command, and press <b>Enter</b> .	CAL:IMP
48. Wait for the ac source to compute the output impedance calibration constant. The display returns to Meter mode when the calculation is complete.	

The ac source is now holding the new output impedance calibration constants in RAM.

## Saving the Calibration Constants

---

**CAUTION:** Storing calibration constants overwrites the existing ones in non-volatile memory. If you are not sure you want to permanently store the new constants, omit this step. The ac source calibration will then remain unchanged.

---

Action	Display
49. Press <b>Shift Calibration</b> , scroll to CAL SAVE, and press <b>Enter</b> .	CAL:SAVE
50. Press <b>Shift Calibration</b> , select CAL OFF, and press <b>Enter</b> to exit Calibration mode. *RST and *RCL will also set the calibration state to OFF.	CAL OFF

## Changing the Calibration Password

The factory default password is 0. You can change the password when the ac source is in calibration mode (which requires you to enter the existing password). Proceed as follows:

Action	Display
1. Begin by pressing <b>Shift Cal</b> and scrolling to the CAL ON command.	CAL ON 0.0
2. Enter the existing password from Entry keypad and press <b>Enter</b>	
3. Press <b>Shift Cal</b> and scroll to the CAL PASS command.	CAL:PASS 0
4. Enter the new password from the keypad. You can use any number with up to six digits and an optional decimal point. If you want the calibration function to operate without requiring any password, change the password to 0 (zero).	

**NOTE:** If you want the calibration function to operate without requiring any password, change the password to 0 (zero).

## Calibration Error Messages

Errors that can occur during calibration are shown in the following table.

**Table B-5. GPIB Calibration Error Messages**

Error	Meaning
401	CAL switch prevents calibration (This is a hardware disable, see the ac source Service Manual.)
402	CAL password is incorrect
403	CAL not enabled
404	Computed readback cal constants are incorrect
405	Computed programming cal constants are incorrect
406	Incorrect sequence of calibration commands

## Calibration Over the GPIB

You can calibrate the ac source by using SCPI commands within your controller programming statements. Be sure you are familiar with calibration from the front panel before you calibrate from a controller. Each front panel calibration command has a corresponding SCPI command.

The SCPI calibration commands are explained in Chapter 3 of the ac source Programming Guide. Calibration error messages that can occur during GPIB calibration are shown in table B-3.

## Agilent Calibration Program Listing

Figure B-2, Sheets 1 through 3, lists the calibration program. This program can be run on any controller operating under Agilent BASIC. The assumed power supply address is 705 and calibration password is 0. If required, change these parameters in the appropriate statements.

```

10      !
20      ! AC Source calibration program                      Rev B.00.00
30      !
40      ASSIGN @Ac TO 705
50      !
60      PRINT TABXY(5,5),"This program will calibrate the 6811B/12B/13B AC Power Solutions."
70      PRINT TABXY(5,7),"Equipment requirements are:      Agilent3458A or equivalent DVM"
80      PRINT TABXY(37,8),"0.01 ohm <200ppm Current Shunt"
90      PRINT TABXY(37,9),"20 ohm >1800 watt power resistor for all models"
100     PRINT TABXY(37,10),"1 ohm >100 watt impedance resistor"
110     PRINT TABXY(37,11),"30:1 <50ppm Ratio Transformer"
120     PRINT TABXY(3,13),"Ratio Transformer is required to when calibrating to MIL-STD-45662A. If the"
130     PRINT TABXY(2,14),"ratio transformer is not used the measurement uncertainty must be recalculated."
140     !
150     DISP "Press CONT to continue"
160     PAUSE
170     CLEAR SCREEN
180     PRINT TABXY(15,5),"1. Turn the AC Source off"
190     PRINT TABXY(15,7),"2. Disconnect all loads"
200     PRINT TABXY(15,9),"3. Connect the 3458A to the rear terminal block"
210     PRINT TABXY(15,11),"4. Set the 3458A to DC VOLTS"
220     PRINT TABXY(15,13),"5. Turn on the AC Source"
230     !
240     DISP "Press CONT to begin DC OFFSET and DC GAIN calibration"
250     PAUSE
260     CLEAR SCREEN
270     PRINT TABXY(25,5),"CALIBRATING VOLTAGE OFFSET"
280     PRINT TABXY(20,7),"There are 4 points to be calibrated"
290     OUTPUT @Ac;"CAL:STATE ON"
300     OUTPUT @Ac;"CAL:VOLT:OFFS"
310     OUTPUT @Ac;"CAL:LEV P1"
320     WAIT 10
330     INPUT "Enter DC offset voltage reading from DVM",Off_p1
340     PRINT TABXY(25,9),"Point 1 entered"
350     OUTPUT @Ac;"CAL:DATA";Off_p1
360     OUTPUT @Ac;"CAL:LEV P2"
370     WAIT 10
380     INPUT "Enter DC offset voltage reading from DVM",Off_p2
390     PRINT TABXY(25,11),"Point 2 entered"
400     OUTPUT @Ac;"CAL:DATA";Off_p2
410     OUTPUT @Ac;"CAL:LEV P3"
420     WAIT 10
430     INPUT "Enter DC offset voltage reading from DVM",Off_p3
440     PRINT TABXY(25,13),"Point 3 entered"
450     OUTPUT @Ac;"CAL:DATA";Off_p3
460     OUTPUT @Ac;"CAL:LEV P4"
470     WAIT 10
480     INPUT "Enter DC offset voltage reading from DVM",Off_p4
490     PRINT TABXY(25,15),"Point 4 entered"
500     OUTPUT @Ac;"CAL:DATA";Off_p4
510     WAIT 3
520     CLEAR SCREEN
530     PRINT TABXY(25,5),"CALIBRATING DC VOLTAGE GAIN"
540     PRINT TABXY(20,7),"There are 3 points to be calibrated"
550     OUTPUT @Ac;"CAL:VOLT:DC"

```

Figure B-2. Calibration Program Listing (Sheet 1 of 3)

## B - Verification and Calibration

```
560 OUTPUT @Ac;"CAL:LEV P1"
570 WAIT 10
580 INPUT "Enter DC voltage reading from DVM",Dc_p1
590 PRINT TABXY(25,9),"Point 1 entered"
600 OUTPUT @Ac;"CAL:DATA";Dc_p1
610 OUTPUT @Ac;"CAL:LEV P2"
620 WAIT 10
630 INPUT "Enter DC voltage reading from DVM",Dc_p2
640 PRINT TABXY(25,11),"Point 2 entered"
650 OUTPUT @Ac;"CAL:DATA";Dc_p2
660 OUTPUT @Ac;"CAL:LEV P3"
670 WAIT 10
680 INPUT "Enter DC voltage reading from DVM",Dc_p3
690 PRINT TABXY(25,13),"Point 3 entered"
700 OUTPUT @Ac;"CAL:DATA";Dc_p3
710 WAIT 3
720 CLEAR SCREEN
730 PRINT TABXY(5,10),"1. Connect the 3458A to the rear terminals via the ratio transformer"
740 PRINT TABXY(18,12),"2. Set the 3458A to AC VOLTS"
750 !
760 DISP "Press CONT to begin AC PROGRAMMING and MEASUREMENT calibration"
770 PAUSE
780 CLEAR SCREEN
790 PRINT TABXY(18,5),"CALIBRATING AC POGRAMMING and MEASUREMENT"
800 PRINT TABXY(20,7),"There are 4 points to be calibrated"
810 OUTPUT @Ac;"CAL:VOLT:AC"
820 OUTPUT @Ac;"CAL:LEV P1"
830 WAIT 10
840 INPUT "Enter AC rms ( transformer ratio * DVM reading)",Ac_p1
850 PRINT TABXY(25,9),"Point 1 entered"
860 OUTPUT @Ac;"CAL:DATA";Ac_p1
870 OUTPUT @Ac;"CAL:LEV P2"
880 WAIT 10
890 INPUT "Enter AC rms ( transformer ratio * DVM reading)",Ac_p2
900 PRINT TABXY(25,11),"Point 2 entered"
910 OUTPUT @Ac;"CAL:DATA";Ac_p2
920 OUTPUT @Ac;"CAL:LEV P3"
930 WAIT 10
940 INPUT "Enter AC rms ( transformer ratio * DVM reading)",Ac_p3
950 PRINT TABXY(25,13),"Point 3 entered"
960 OUTPUT @Ac;"CAL:DATA";Ac_p3
970 OUTPUT @Ac;"CAL:LEV P4"
980 WAIT 3
990 INPUT "Enter AC rms ( transformer ratio * DVM reading)",Ac_p4
1000 PRINT TABXY(25,15),"Point 4 entered"
1010 OUTPUT @Ac;"CAL:DATA";Ac_p4
1020 WAIT 10
1030 CLEAR SCREEN
1040 PRINT TABXY(15,10),"CALIBRATING OVERVOLTAGE PROTECTION"
1050 OUTPUT @Ac;"CAL:VOLT:PROT"
1060 PRINT TABXY(30,15),"WAIT"
1070 WAIT 30
1071 OUTPUT @Ac;"CAL:SAVE"
1072 OUTPUT @Ac;"CAL:STATE OFF"
1080 CLEAR SCREEN
1090 PRINT TABXY(15,5),"1. Turn off the AC Source"
1100 PRINT TABXY(15,7),"2. Connect the current shunt and 20 ohm load resistor, see fig.B-1"
```

Figure B-2. Calibration Program Listing (Sheet 2 of 3)

```

1110 PRINT TABXY(15,9),"3. Connect the 3458A across the current shunt"
1120 PRINT TABXY(15,11),"4. Set the 3458A to AC rms VOLTS"
1130 PRINT TABXY(15,13),"5. Turn on the AC Source"
1140 !
1150 DISP "Press CONT to begin Current Program and Measurement calibration"
1160 PAUSE
1170 CLEAR SCREEN
1180 PRINT TABXY(22,5),"CALIBRATING CURRENT POGRAMMING"
1190 PRINT TABXY(20,7),"There are 2 points to be calibrated"
1191 OUTPUT @Ac;"CAL:STATE ON"
1200 OUTPUT @Ac;"CAL:CURR:AC"
1210 OUTPUT @Ac;"CAL:LEV P1"
1220 WAIT 10
1230 INPUT "Enter AC rms current ( DVM reading divided by shunt resistance )",Ai_p1
1240 PRINT TABXY(25,9),"Point 1 entered"
1250 OUTPUT @Ac;"CAL:DATA";Ai_p1
1260 OUTPUT @Ac;"CAL:LEV P2"
1270 WAIT 10
1280 INPUT "Enter AC rms current ( DVM reading divided by shunt resistance )",Ai_p2
1290 PRINT TABXY(25,11),"Point 2 entered"
1300 OUTPUT @Ac;"CAL:DATA";Ai_p2
1310 WAIT 10
1320 CLEAR SCREEN
1330 PRINT TABXY(22,5),"CALIBRATING CURRENT MEASUREMENT"
1340 PRINT TABXY(20,7),"There are 2 points to be calibrated"
1350 OUTPUT @Ac;"CAL:CURR:MEAS"
1360 OUTPUT @Ac;"CAL:LEV P1"
1370 WAIT 10
1380 INPUT "Enter AC rms current ( DVM reading divided by shunt resistance )",Am_p1
1390 PRINT TABXY(25,9),"Point 1 entered"
1400 OUTPUT @Ac;"CAL:DATA";Am_p1
1410 OUTPUT @Ac;"CAL:LEV P2"
1420 WAIT 10
1430 INPUT "Enter AC rms current ( DVM reading divided by shunt resistance )",Am_p2
1440 PRINT TABXY(25,11),"Point 2 entered"
1450 OUTPUT @Ac;"CAL:DATA";Am_p2
1460 WAIT 10
1470 OUTPUT @Ac;"CAL:SAVE"
1480 OUTPUT @Ac;"CAL:STATE OFF"
1490 CLEAR SCREEN
1500 !
1510 !
1520 PRINT TABXY(15,5),"1. Turn off the AC Source"
1530 PRINT TABXY(15,7),"2. Disconnect all equipment from the AC Source"
1540 PRINT TABXY(15,9),"3. Connect the 1 ohm impedance resistor, see fig.B-1"
1550 PRINT TABXY(15,11),"4. Turn on the AC Source"
1560 !
1570 DISP "Press CONT to begin Output Impedance calibration"
1580 PAUSE
1590 PRINT TABXY(15,10),"CALIBRATING OUTPUT IMPEDANCE"
1600 OUTPUT @Ac;"CAL:STATE ON"
1610 OUTPUT @Ac;"CAL:IMP"
1620 PRINT TABXY(30,15),"WAIT"
1630 WAIT 30
1640 OUTPUT @Ac;"CAL:SAVE"
1650 OUTPUT @Ac;"CAL:STATE OFF"
1660 CLEAR SCREEN
1670 PRINT TABXY(25,10),"CALIBRATION COMPLETE"
1680 END

```

Figure B-2. Calibration Program Listing (Sheet 3 of 3)





## Error Messages

### Error Number List

This appendix gives the error numbers and descriptions that are returned by the ac source. Error numbers are returned in two ways:

- ◆ Error numbers are displayed on the front panel
- ◆ Error numbers and messages are read back with the SYSTem:ERRor? query. SYSTem:ERRor? returns the error number into a variable and returns two parameters: an NR1 and a string.

The following table lists the errors that are associated with SCPI syntax errors and interface problems. It also lists the device dependent errors. Information inside the brackets is not part of the standard error message, but is included for clarification. When errors occur, the Standard Event Status register records them in bit 2, 3, 4, or 5:

**Table C-1. Error Numbers**

Error Number	Error String [Description/Explanation/Examples]
	<b>Command Errors –100 through –199 (sets Standard Event Status Register bit #5)</b>
–100	Command error [generic]
–101	Invalid character
–102	Syntax error [unrecognized command or data type]
–103	Invalid separator
–104	Data type error [e.g., "numeric or string expected, got block data"]
–105	GET not allowed
–108	Parameter not allowed [too many parameters]
–109	Missing parameter [too few parameters]
–112	Program mnemonic too long [maximum 12 characters]
–113	Undefined header [operation not allowed for this device]
–121	Invalid character in number [includes "9" in octal data, etc.]
–123	Numeric overflow [exponent too large; exponent magnitude >32 k]
–124	Too many digits [number too long; more than 255 digits received]
–128	Numeric data not allowed
–131	Invalid suffix [unrecognized units, or units not appropriate]
–138	Suffix not allowed
–141	Invalid character data [bad character, or unrecognized]
–144	Character data too long
–148	Character data not allowed
–150	String data error
–151	Invalid string data [e.g., END received before close quote]
–158	String data not allowed
–160	Block data error

## C - Error Messages

-161	Invalid block data [e.g., END received before length satisfied]
-168	Block data not allowed
-170	Expression error
-171	Invalid expression
-178	Expression data not allowed
<b>Execution Errors –200 through –299 (sets Standard Event Status Register bit #4)</b>	
-200	Execution error [generic]
-221	Settings conflict [check current device state]
-222	Data out of range [e.g., too large for this device]
-223	Too much data [out of memory; block, string, or expression too long]
-224	Illegal parameter value [device-specific]
-225	Out of memory
-270	Macro error
-272	Macro execution error
-273	Illegal macro label
-276	Macro recursion error
-277	Macro redefinition not allowed
<b>System Errors –300 through –399 (sets Standard Event Status Register bit #3)</b>	
-310	System error [generic]
-350	Too many errors [errors beyond 9 lost due to queue overflow]
<b>Query Errors –400 through –499 (sets Standard Event Status Register bit #2)</b>	
-400	Query error [generic]
-410	Query INTERRUPTED [query followed by DAB or GET before response complete]
-420	Query UNTERMINATED [addressed to talk, incomplete programming message received]
-430	Query DEADLOCKED [too many queries in command string]
-440	Query UNTERMINATED [after indefinite response]
<b>Selftest Errors 0 through 99 (sets Standard Event Status Register bit #3)</b>	
0	No error
1	Non-volatile RAM RD0 section checksum failed
2	Non-volatile RAM CONFIG section checksum failed
3	Non-volatile RAM CAL section checksum failed
4	Non-volatile RAM WAVEFORM section checksum failed
5	Non-volatile RAM STATE section checksum failed
6	Non-volatile RAM LIST section checksum failed
7	Non-volatile RAM RST section checksum failed
10	RAM selftest
11 - 31	DAC selftest error, expected <n>, read <reading> Errors 11, 12, 13, 14, 15 apply to DAC12 1A and 1B Errors 16, 17, 18 apply to DAC12 2A Errors 19, 20, 21 apply to DAC12 2B Errors 22, 23 apply to DAC12 4A Errors 24, 25 apply to DAC12 4B Errors 26, 27, 28 apply to DAC12 3A and 3B Errors 29, 30, 31 apply to DAC12 5A and 5B

40	Voltage selftest error, output 1
41	Voltage selftest error, output 2
42	Voltage selftest error, output 3
43	Current selftest error, output 1
44	Current selftest error, output 2
45	Current selftest error, output 3
70	Fan voltage failure
80	Digital I/O selftest error
<b>Device-Dependent Errors 100 through 32767 (sets Standard Event Status Register bit #3)</b>	
200	Outgrd not responding
201	Front panel not responding
210	Ingrd receiver framing error
211	Ingrd uart overrun status
212	Ingrd received bad token
213	Ingrd receiver buffer overrun
214	Ingrd input buffer overrun
215	Outgrd output buffer overrun
216	RS-232 receiver framing error
217	RS-232 receiver parity error
218	RS-232 receiver overrun error
219	Ingrd inbuf count sync error
220	Front panel uart overrun
221	Front panel uart framing
222	Front panel uart parity
223	Front panel buffer overrun
224	Front panel timeout
401	CAL switch prevents calibration
402	CAL password is incorrect
403	CAL not enabled
404	Computed readback cal constants are incorrect
405	Computed programming cal constants are incorrect
406	Incorrect sequence of calibration commands
600	Systems in mode:list have different list lengths
601	Requested voltage and waveform exceeds peak voltage capability
602	Requested voltage and waveform exceeds transformer volt-second rating
603	Command only applies to RS-232 interface
604	Trigger received before requested number of pre-trigger readings
605	Requested RMS current too high for voltage range
606	Waveform data not defined
607	VOLT, VOLT:SLEW, and FUNC:SHAP modes incompatible
608	Measurement overrange
609	Output buffer overrun
610	Command cannot be given with present SYST:CONF setting



## Line Voltage Conversion

---

**WARNING:** *Shock Hazard* Hazardous voltage can remain inside the unit even after it has been turned off. This procedure should only be done by qualified electronics service personnel.

---

### Open the Unit

- ◆ Turn off the ac power to the unit and disconnect the power cord from the power outlet.
- ◆ Remove the four screws that secure the two carrying straps and outer cover (use a T25 Torx drive).
- ◆ Slightly spread the bottom rear of the cover and pull it back to remove it from the front panel.
- ◆ Observe the two LEDs that are visible in the cutouts on each side of the unit. **If either LED is on, there is hazardous voltage inside the unit.** Wait until the LED goes out before proceeding (this may take several minutes).

### Check the Jumper Wire (Model Agilent 6811B/6812B only)

- ◆ Locate the line voltage jumper wire in the cutout at the side of the unit by the line cord (see Figure D-1).
- ◆ For 100 V or 120 V operation, install the jumper on the lug labeled:100/120.  
For 200 V, 208 V or 230 V operation, install the jumper on the lug labeled: 200/220.

### Check the Line Jumpers (all Models)

- ◆ Locate the line jumpers in the cutout at the side of the unit by the on/off switch.
- ◆ Configure the jumpers according to the line voltage shown in the accompanying label. When configuring a unit for 208 V, use the jumper settings shown for 200 V.

### Check the Power Transformer Connector (all Models)

---

**NOTE:** This procedure is only required if you are changing the input voltage between 100 V and 120 V or between 200/208 V and 230 V.

---

- ◆ Remove the screws securing the inner cover (use a T15 Torx drive).
- ◆ Remove the inner cover.
- ◆ Remove the screws securing the pc board behind the front panel (use a T15 Torx drive).

## D - Line Voltage Conversion

- ◆ You need only to lift the board out of the way, you do not need to disconnect any cables.
- ◆ Locate the connector in front of the power transformer.
- ◆ For 100 V, 200 V, or 208 V operation, install the plug on the connector labeled: 200 V input.
- ◆ For 120 V or 230 V operation, install the plug on the connector labeled: 240 V input.
- ◆ Replace the pc board and inner cover.

---

**NOTE:** Be sure to replace all of the screws removed in steps 9 and 11.

---

## Close the Unit

- ◆ Replace the outer cover.
- ◆ Change the label on the rear panel to reflect the changed input voltage rating.
- ◆ Reconnect the power and turn on the unit.

---

**NOTE:** Line voltage conversion does not require any fuse changes.

---

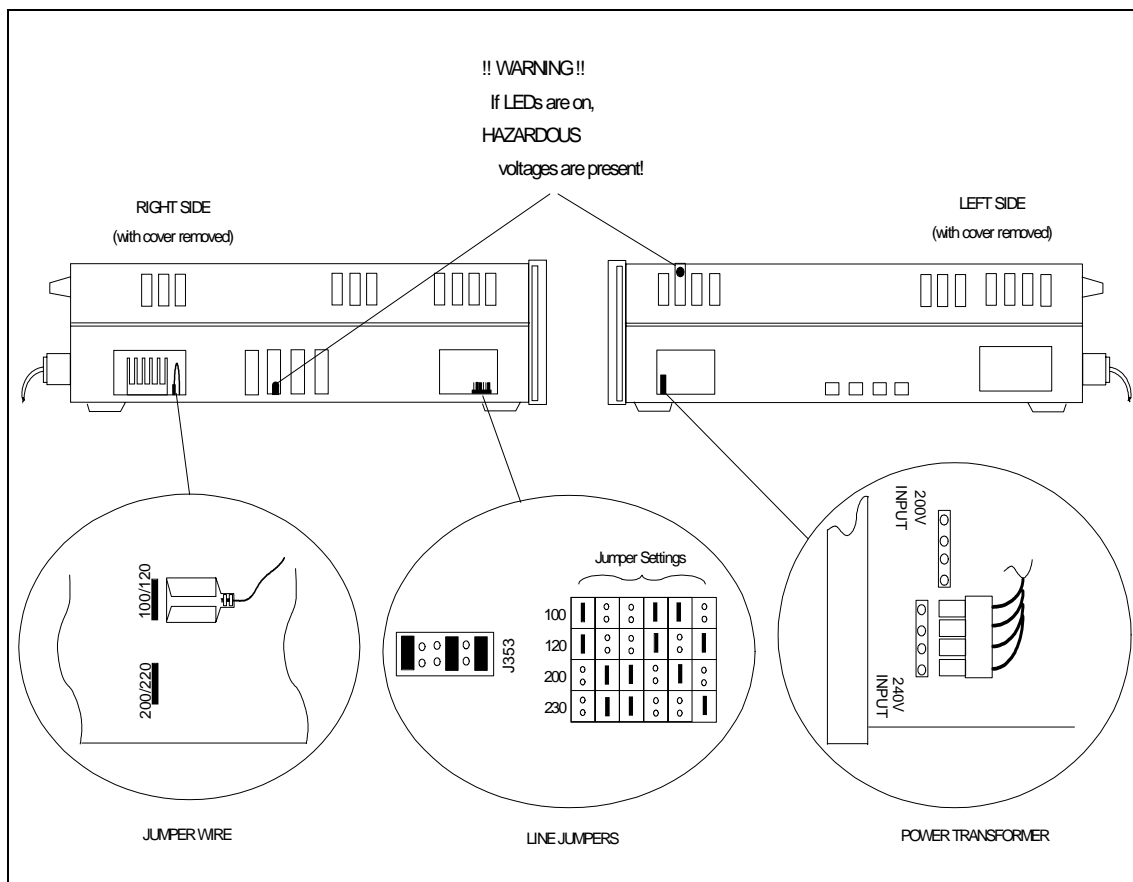

Figure D-1. Line Voltage Conversion Components

# Index

## —A—

- ac line conversion, 85
- accessories, 12
- airflow, 22
- annunciators
  - φ1, 38
  - Addr, 38
  - Cal, 38
  - CC, 38
  - CV, 38
  - Dis, 38
  - Err, 38
  - OCP, 38
  - Prot, 38
  - Rmt, 38
  - Shift, 38
  - SRQ, 38
  - Tran, 38
  - Unr, 38
- AWG ratings, 25

## —C—

- cables, 12
- calibration, 71
  - ac rms voltage gain, 73
  - dc voltage gain, 73
  - enable, 72
  - equipment, 65
  - error messages, 76
  - menu, 71
  - output impedance, 75
  - OVP, 74
  - password, 76
  - program listing, 76
  - rms current, 74, 75
  - saving, 75
  - setup, 66
  - voltage offset, 72
- capabilities, 14
- cleaning, 21
- conversion, ac line, 85

## —D—

- damage, 21
- dc offset, 48
- digital connections, 27
- digital connector, 21
- dimensions, 22

## —E—

- entry keys, 46
  - ←, 46
  - 0 ... 9, 46
  - Clear Entry, 46
  - E, 46
  - Enter, 46
- error messages, 34
- error numbers, 81

## —F—

- features, 13
- Fixed, 50
- FLT connections, 27
- frequency control, 14
- front panel, 37
  - annunciators, 38
  - controls and indicators, 14, 37
  - keys, 38
- function keys, 40
  - ▲, 40
  - ▲Index, 40
  - immediate action, 40
  - Output On/Off, 40
  - Phase Select, 40
  - Trigger, 40
- fuses, 23

## —G—

- general information, 11
- ground, earth, 12
- guide, programming, 11
- guide, user's, 11
- GPIB, 58
  - address, 58
  - connections, 28

## —H—

- hazardous voltages, 65
- history, 6

## —I—

- INH connections, 27
- input
  - connections, 23
  - power, 12
- inrush current capability, 17
- inspection, 21

## Index

### —L—

- lethal voltages, 65
- line fuse
  - replacing, 35
- line voltage conversion, 85
- List, 50, 52
- load regulation, 18
- load voltage drops, 25
- location, 22
- low frequency operation (<45 Hz), 15, 63

### —M—

- manuals, 11, 21
- measure
  - ac only, 48
  - ac+dc, 48
  - dc only, 48
- meter
  - ac, 48
  - ac+dc, 48
  - dc, 48
- Meter AC+DC, 38
- meter display keys
  - Harmonic, 41
  - Input, 41
  - Meter, 41

### —N—

- non-volatile memory
  - clearing, 58
  - storing, 39

### —O—

- OCP, 49
- offset, 48
- operating features, 13
- options, 12
- OT, 49
- output
  - ac+dc, 48
  - characteristic, 15
  - clearing output protection, 49
  - connections, 24
  - connector, 21
  - control keys
    - Output, 43
  - rating, 15
  - setting output protection, 49
  - setting the amplitude, 47
  - setting the dc offset, 48
  - setting the frequency, 48
- Output AC+DC, 38
- output checkout, 32
- output control keys
  - Current, 42
  - Freq, 42

- Phase, 43
- Pulse, 43
- Shape, 43
- Voltage, 42
- output coupling
  - ac, 19, 48
  - dc, 19, 48
- output impedance
  - <1 ohm, 18
  - reactive, 18
  - real, 18
- OV, 49
- OVL, 34

### —P—

- parts - operator replaceable, 13
- peak current capability, 16
- peak current limit, 16
- peak inrush capacitance, 16
- Peak Inrush current
  - measuring, 57
- Phase synchronization, 53
- power cord, 21
  - installation, 23
- power receptacle, 12
- preliminary checkout, 31
- print date, 6
- program listing
  - calibration, 76
- protection
  - OCP, 49
  - OT, 49
  - OV, 49
  - Rail, 49
  - RI, 49
  - SOA, 49
- protection/status keys
  - Protect, 44
  - Status, 44
- Pulse, 51

### —R—

- rack mount kit, 12
- rack mounting, 22
- Rail, 49
- real-time voltage regulation, 18
- recalling operating states, 58
- remote programming, 15
- remote sensing, 25
  - OVP considerations, 27
- repacking, 21
- RI, 49
- rms current limit, 18
- rms voltage regulation, 18
- RS-232, 58
  - connections
    - interface commands, 29
  - data format, 29
  - handshake, 30



interface cable, 30  
pinouts, 29

### —S—

safety class, 12  
safety summary, 3  
safety warning, 12  
saving operating states, 58  
self-test, 31  
selftest errors, 34  
sense connections, 25  
service guide, 12  
shift annunciator, 32  
shift key, 32  
Slew rates  
  programming, 55  
SOA, 49  
SOA limit, 16  
specifications, 59  
Step, 50  
supplemental characteristics, 61  
SYSTEM  
  LOCal, 29  
  REMote, 29  
  RWLock, 29  
system errors, 81  
system keys, 39  
  Address, 39  
  Error, 39  
  Interface, 39  
  Local, 39  
  RCL, 39  
  Save, 39  
  Shift, 39

### —T—

transient voltage  
  fixed, 50  
  list, 50, 52  
  pulse, 51  
  step, 50  
transient voltage mode, 50  
trigger connections, 27  
Trigger delays, 53  
trigger IN, 27  
trigger OUT, 27  
trigger/list keys  
  List, 45  
  Trigger Control, 45  
turn-on checkout, 31, 67

### —V—

verification, 32  
  ac measurement accuracy, 67  
  ac voltage programming, 67  
  dc measurement accuracy, 68  
  dc voltage programming, 68

equipment, 65  
  rms current accuracy, 68  
  setup, 66  
  test record, 69  
verification tests, 31  
voltage control, 14  
voltage regulation  
  real-time, 18  
  rms, 18

### —W—

warranty, 2  
Waveform  
  generation, 55  
wire  
  current ratings, 25  
wiring considerations, 25

## Agilent Sales and Support Offices

For more information about Agilent Technologies test and measurement products, applications, services, and for a current sales office listing, visit our web site:

<http://www.agilent.com/find/tmdir>

You can also contact one of the following centers and ask for a test and measurement sales representative.

### United States:

Agilent Technologies  
Test and Measurement Call Center  
P.O. Box 4026  
Englewood, CO 80155-4026  
(tel) 1 800 452 4844

### Latin America:

Agilent Technologies  
Latin American Region Headquarters  
5200 Blue Lagoon Drive, Suite #950  
Miami, Florida 33126  
U.S.A.  
(tel) (305) 267 4245  
(fax) (305) 267 4286

### Canada:

Agilent Technologies Canada Inc.  
5150 Spectrum Way  
Mississauga, Ontario  
L4W 5G1  
(tel) 1 877 894 4414

### Australia/New Zealand:

Agilent Technologies Australia Pty Ltd  
347 Burwood Highway  
Forest Hill, Victoria 3131  
(tel) 1-800 629 485 (Australia)  
(fax) (61 3) 9272 0749  
(tel) 0 800 738 378 (New Zealand)  
(fax) (64 4) 802 6881

### Europe:

Agilent Technologies  
Test & Measurement European Marketing Organisation  
P.O. Box 999  
1180 AZ Amstelveen  
The Netherlands  
(tel) (31 20) 547 9999

### Asia Pacific:

Agilent Technologies  
24/F, Cityplaza One, 1111 King's Road,  
Taikoo Shing, Hong Kong  
tel: (852)-3197-7777  
fax: (852)-2506-9284

### Japan:

Agilent Technologies Japan Ltd.  
Measurement Assistance Center  
9-1, Takakura-Cho, Hachioji-Shi,  
Tokyo 192-8510, Japan  
(tel) (81) 426 56 7832  
(fax) (81) 426 56 7840

Technical data is subject to change.

## Manual Updates

The following updates have been made to this manual since the print revision indicated on the title page.

4/15/00

All references to HP have been changed to Agilent.

All references to HP-IB have been changed to GPIB.

12/12/02

Additional information about power cords for model 6811B has been added to chapters 1 and 2.

Corrections have been made to the rms current measurement accuracy verification procedure for all models in appendix B.

The Canada ICES/NMB-001 statement has been added to page 3.

9/20/04

The Declaration of Conformity has been updated. A correction has been made to the Checkout Procedure in chapter 3.